

## V-4EX 4-CHANNEL VIDEO MIXER

# Owner's Manual

Before using this unit, carefully read the sections entitled "USING THE UNIT SAFELY" (p. 3) and "IMPORTANT NOTES" (p. 5). These sections provide important information concerning the proper operation of the unit. Additionally, in order to feel assured that you have gained a good grasp of every feature of your new unit, owner's manual should be read in its entirety. This manual should be saved and kept on hand as a convenient reference.



Copyright © 2012 ROLAND CORPORATION

All rights reserved. No part of this publication may be reproduced in any form without the written permission of ROLAND CORPORATION.

- \* Roland is either registered trademark or trademark of Roland Corporation in the United States and/or other countries.
- \* All product names mentioned in this document are trademarks or registered trademarks of their respective owners.

For the U.K.

**IMPORTANT:** THE WIRES IN THIS MAINS LEAD ARE COLOURED IN ACCORDANCE WITH THE FOLLOWING CODE.

BLUE: NEUTRAL  
BROWN: LIVE

As the colours of the wires in the mains lead of this apparatus may not correspond with the coloured markings identifying the terminals in your plug, proceed as follows:

The wire which is coloured BLUE must be connected to the terminal which is marked with the letter N or coloured BLACK.



The wire which is coloured BROWN must be connected to the terminal which is marked with the letter L or coloured RED.

Under no circumstances must either of the above wires be connected to the earth terminal of a three pin plug.



# USING THE UNIT SAFELY

## INSTRUCTIONS FOR THE PREVENTION OF FIRE, ELECTRIC SHOCK, OR INJURY TO PERSONS

### About ⚠ WARNING and ⚠ CAUTION Notices

 <b>WARNING</b>	Used for instructions intended to alert the user to the risk of death or severe injury should the unit be used improperly.
 <b>CAUTION</b>	Used for instructions intended to alert the user to the risk of injury or material damage should the unit be used improperly. * Material damage refers to damage or other adverse effects caused with respect to the home and all its furnishings, as well to domestic animals or pets.

### About the Symbols

	The ⚠ symbol alerts the user to important instructions or warnings. The specific meaning of the symbol is determined by the design contained within the triangle. In the case of the symbol at left, it is used for general cautions, warnings, or alerts to danger.
	The ⚡ symbol alerts the user to items that must never be carried out (are forbidden). The specific thing that must not be done is indicated by the design contained within the circle. In the case of the symbol at left, it means that the unit must never be disassembled.
	The ⏻ symbol alerts the user to things that must be carried out. The specific thing that must be done is indicated by the design contained within the circle. In the case of the symbol at left, it means that the power-cord plug must be unplugged from the outlet.

### ALWAYS OBSERVE THE FOLLOWING

## WARNING

#### To completely turn off power to the unit, pull out the plug from the outlet

- Even with the power switch turned off, this unit is not completely separated from its main source of power. When the power needs to be completely turned off, turn off the power switch on the unit, then pull out the plug from the outlet. For this reason, the outlet into which you choose to connect the power cord's plug should be one that is within easy reach and readily accessible.



#### Concerning the AUTO OFF function

- The power to this unit will be turned off automatically after a predetermined amount of time has passed since its buttons or controls were last operated (AUTO OFF function). If you do not want the power to be turned off automatically, disengage the AUTO OFF function (p. 10).



#### Do not disassemble or modify by yourself

- Do not open or perform any internal modifications on the unit or its AC adaptor. (The only exception would be where this manual provides specific instructions which should be followed in order to put in place the video fader; see p. 57.)



#### Do not repair or replace parts by yourself

- Do not attempt to repair the unit, or replace parts within it (except when this manual provides specific instructions directing you to do so). Refer all servicing to your retailer, the nearest Roland Service Center, or an authorized Roland distributor, as listed on the "Information" sheet.



#### Do not use or store in the following types of locations

- Subject to temperature extremes (e.g., direct sunlight in an enclosed vehicle, near a heating duct, on top of heat-generating equipment); or are
- Damp (e.g., baths, washrooms, on wet floors); or are
- Exposed to steam or smoke; or are
- Subject to salt exposure; or are
- Humid; or are
- Exposed to rain; or are
- Dusty or sandy; or are
- Subject to high levels of vibration and shakiness.



## WARNING

#### Do not place in an unstable location

- Make sure you always have the unit placed so it is level and sure to remain stable. Never place it on stands that could wobble, or on inclined surfaces.



#### Use only the supplied AC adaptor and the correct voltage

- Be sure to use only the AC adaptor supplied with the unit. Also, make sure the line voltage at the installation matches the input voltage specified on the AC adaptor's body. Other AC adaptors may use a different polarity, or be designed for a different voltage, so their use could result in damage, malfunction, or electric shock.



#### Use only the supplied power cord

- Use only the attached power-supply cord. Also, the supplied power cord must not be used with any other device.



#### Do not bend the power cord or place heavy objects on it

- Do not excessively twist or bend the power cord, nor place heavy objects on it. Doing so can damage the cord, producing severed elements and short circuits. Damaged cords are fire and shock hazards!



#### Don't allow foreign objects or liquids to enter unit; never place containers with liquid on unit

- Do not place containers containing liquid (e.g., flower vases) on this product. Never allow foreign objects (e.g., flammable objects, coins, wires) or liquids (e.g., water or juice) to enter this product. Doing so may cause short circuits, faulty operation, or other malfunctions.



## WARNING

### Turn off the unit if an abnormality or malfunction occurs

- Immediately turn the unit off, remove the AC adaptor from the outlet, and request servicing by your retailer, the nearest Roland Service Center, or an authorized Roland distributor, as listed on the "Information" sheet when:
  - The AC adaptor, the power-supply cord, or the plug has been damaged; or
  - If smoke or unusual odor occurs; or
  - Objects have fallen into, or liquid has been spilled onto the unit; or
  - The unit has been exposed to rain (or otherwise has become wet); or
  - The unit does not appear to operate normally or exhibits a marked change in performance.

### Adults must provide supervision in places where children are present

- When using the unit in locations where children are present, be careful so no mishandling of the unit can take place. An adult should always be on hand to provide supervision and guidance.

### Do not drop or subject to strong impact

- Protect the unit from strong impact. (Do not drop it!)

### Do not share an outlet with an unreasonable number of other devices

- Do not force the unit's power-supply cord to share an outlet with an unreasonable number of other devices. Be especially careful when using extension cords - the total power used by all devices you have connected to the extension cord's outlet must never exceed the power rating (watts/amperes) for the extension cord. Excessive loads can cause the insulation on the cord to heat up and eventually melt through.

### Do not use overseas

- Before using the unit in overseas, consult with your retailer, the nearest Roland Service Center, or an authorized Roland distributor, as listed on the "Information" sheet.

### Turn the unit off before removing the video fader

- Always turn the unit off and unplug the AC adaptor before attempting to remove the video fader (p. 57).

## CAUTION

### Place in a well ventilated location

- The unit and the AC adaptor should be located so their location or position does not interfere with their proper ventilation.

### When disconnecting an AC adaptor, grasp it by the plug

- To prevent conductor damage, always grasp the AC adaptor by its plug when disconnecting it from this unit or from a power outlet.

## CAUTION

### Periodically clean the AC adaptor's plug

- At regular intervals, you should unplug the AC adaptor and clean it by using a dry cloth to wipe all dust and other accumulations away from its prongs. Also, disconnect the power plug from the power outlet whenever the unit is to remain unused for an extended period of time. Any accumulation of dust between the power plug and the power outlet can result in poor insulation and lead to fire.

### Manage cables for safety

- Try to prevent cords and cables from becoming entangled. Also, all cords and cables should be placed so they are out of the reach of children.

### Avoid climbing on top of the unit, or placing heavy objects on it

- Never climb on top of, nor place heavy objects on the unit.

### Do not connect or disconnect the AC adaptor with wet hands

- Never handle the AC adaptor or its plugs with wet hands when plugging into, or unplugging from, an outlet or this unit.

### Disconnect everything before moving the unit

- Before moving the unit, disconnect the AC adaptor and all cords coming from external devices.

### Unplug the AC adaptor from the outlet before cleaning

- Before cleaning the unit, turn it off and unplug the AC adaptor from the outlet (p. 9).

### If there is a possibility of lightning strike, disconnect the AC adaptor from the outlet

- Whenever you suspect the possibility of lightning in your area, disconnect the AC adaptor from the outlet.

### Keep small items out of the reach of children

- To prevent accidental ingestion of the parts listed below, always keep them out of the reach of small children.
  - Included Parts  
RCA - BNC conversion plug
  - Removable Parts  
Screw for the video fader (p. 57)

### Handle the ground terminal carefully

- If you remove the screw from the ground terminal, be sure to replace it; don't leave it lying around where it could accidentally be swallowed by small children. When refastening the screw, make that it is firmly fastened, so it won't come loose.

# IMPORTANT NOTES

## Power Supply

- Do not connect this unit to same electrical outlet that is being used by an electrical appliance that is controlled by an inverter or a motor (such as a refrigerator, washing machine, microwave oven, or air conditioner). Depending on the way in which the electrical appliance is used, power supply noise may cause this unit to malfunction or may produce audible noise. If it is not practical to use a separate electrical outlet, connect a power supply noise filter between this unit and the electrical outlet.
- The AC adaptor will begin to generate heat after long hours of consecutive use. This is normal, and is not a cause for concern.
- To prevent malfunction and equipment failure, always make sure to turn off the power on all your equipment before you make any connections.

## Placement

- Using the unit near power amplifiers (or other equipment containing large power transformers) may induce hum. To alleviate the problem, change the orientation of this unit; or move it farther away from the source of interference.
- This device may interfere with radio and television reception. Do not use this device in the vicinity of such receivers.
- Noise may be produced if wireless communications devices, such as cell phones, are operated in the vicinity of this unit. Such noise could occur when receiving or initiating a call, or while conversing. Should you experience such problems, you should relocate such wireless devices so they are at a greater distance from this unit, or switch them off.
- Do not expose the unit to direct sunlight, place it near devices that radiate heat, leave it inside an enclosed vehicle, or otherwise subject it to temperature extremes. Excessive heat can deform or discolor the unit.
- When moved from one location to another where the temperature and/or humidity is very different, water droplets (condensation) may form inside the unit. Damage or malfunction may result if you attempt to use the unit in this condition. Therefore, before using the unit, you must allow it to stand for several hours, until the condensation has completely evaporated.
- Depending on the material and temperature of the surface on which you place the unit, its rubber feet may discolor or mar the surface. You can place a piece of felt or cloth under the rubber feet to prevent this from happening. If you do so, please make sure that the unit will not slip or move accidentally.
- Do not place containers or anything else containing liquid on top of this unit. Also, whenever any liquid has been spilled on the surface of this unit, be sure to promptly wipe it away using a soft, dry cloth.

## Maintenance

- For everyday cleaning wipe the unit with a soft, dry cloth or one that has been slightly dampened with water. To remove stubborn dirt, use a cloth impregnated with a mild, non-abrasive detergent. Afterwards, be sure to wipe the unit thoroughly with a soft, dry cloth.
- Never use benzene, thinners, alcohol or solvents of any kind, to avoid the possibility of discoloration and/or deformation.

## Repairs and Data

- Please be aware that all data contained in the unit's memory may be lost when the unit is sent for repairs. Important settings should be written down on paper (when possible). During repairs, due care is taken to avoid the loss of data. However, in certain cases (such as when circuitry related to memory itself is out of order), we regret that it may not be possible to restore the data, and Roland assumes no liability concerning such loss of data.

## Additional Precautions

- Please be aware that the contents of memory can be irretrievably lost as a result of a malfunction, or the improper operation of the unit. To protect yourself against the risk of losing important data, we recommend that you periodically write your setting down on paper.
- Unfortunately, it may be impossible to restore the contents of data that was stored in the unit's memory once it has been lost. Roland Corporation assumes no liability concerning such loss of data.
- Use a reasonable amount of care when using the unit's buttons, sliders, or other controls; and when using its jacks and connectors. Rough handling can lead to malfunctions.
- Never strike or apply strong pressure to the display.
- When disconnecting all cables, grasp the connector itself - never pull on the cable. This way you will avoid causing shorts, or damage to the cable's internal elements.
- When you need to transport the unit, package it in the box (including padding) that it came in, if possible. Otherwise, you will need to use equivalent packaging materials.
- Some connection cables contain resistors. Do not use cables that incorporate resistors for connecting to this unit. The use of such cables can cause the sound level to be extremely low, or impossible to hear. For information on cable specifications, contact the manufacturer of the cable.
- This unit allows you to switch images at high speed. For some people, viewing such images can cause headache, nausea, or other discomfort. Do not use this unit to create video that might cause these types of health problems. Roland Corporation will accept no responsibility for any such health problems that may occur in yourself or in viewers.

## About Intellectual Property Rights

- Roland is an either registered trademark or trademark of Roland Corporation in the United States and/or other countries.
- Company names and product names appearing in this document are registered trademarks or trademarks of their respective owners.
- It is forbidden by law to make an audio recording, video recording, copy or revision of a third party's copyrighted work (musical work, video work, broadcast, live performance, or other work), whether in whole or in part, and distribute, sell, lease, perform, or broadcast it without the permission of the copyright owner.
- Do not use this product for purposes that could infringe on a copyright held by a third party. We assume no responsibility whatsoever with regard to any infringements of third-party copyrights arising through your use of this product.
- This product can be used to record or duplicate audio or visual material without being limited by certain technological copy-protection measures. This is due to the fact that this product is intended to be used for the purpose of producing original music or video material, and is therefore designed so that material that does not infringe copyrights belonging to others (for example, your own original works) can be recorded or duplicated freely.
- MMP (Moore Microprocessor Portfolio) refers to a patent portfolio concerned with microprocessor architecture, which was developed by Technology Properties Limited (TPL). Roland has licensed this technology from the TPL Group.

# Check the Included Items

The following items are included. Please make sure that all items are present. If anything is missing, please contact your dealer.

## V-4EX itself



## Owner's manual



## AC adaptor and power cord



## RCA - BNC conversion plug (two)



The explanations in this manual include illustrations that depict what should typically be shown by the display. Note, however, that your unit may incorporate a newer, enhanced version of the system (e.g., includes newer sounds), so what you actually see in the display may not always match what appears in the manual

# Contents

<b>Check the Included Items .....</b>	<b>6</b>
<b>About the Power Supply .....</b>	<b>9</b>
Connecting the AC Adapter .....	9
About the Cord Hook.....	9
Caution Regarding the Power Supply .....	9
Turning the Power On and Off .....	10
<b>Part Names and Functions.....</b>	<b>11</b>
Top Panel.....	11
Rear Panel .....	14
<b>Connecting External Equipment.....</b>	<b>15</b>
Signal Flow .....	15
Connecting Source Equipment.....	16
Connecting Video Source Equipment .....	16
Switching the Enabled Connector .....	17
Connecting Audio Source Equipment.....	18
Connecting Output Equipment.....	19
Connecting a Projector or Recording Unit.....	19
Connecting a Preview Monitor.....	19
Connecting a Computer for Streaming.....	20
Checking the Connections .....	22
<b>About Input/Output Formats .....</b>	<b>23</b>
<b>Inputting HDCP Signals .....</b>	<b>24</b>
<b>Basic Operations .....</b>	<b>25</b>
Switching the Monitor View Mode .....	25
Changing Various Settings .....	26
Switching the Video .....	27
Switching the Picture Using the Video Fader.....	27
Switching Using the Touch Panel .....	28
Switching Using the Transformer Buttons.....	29
Switching Automatically in Time with the Musical Rhythm .....	29
Applying Fade to Final Output.....	31
Freezing the Final Output .....	31
About AUTO SCAN Function.....	31
<b>Applying Filter Effects to Video .....</b>	<b>32</b>
<b>Compositing Two Pictures .....</b>	<b>33</b>
Key Compositing .....	33
Compositing Using Chroma Key.....	33
Compositing Using Luminance Key .....	34
Compositing Using Picture-in-Picture.....	35

**About Other Features .....36**

- Adjusting the Audio Balance/Volume ..... 36
- Aligning the Timing of Video and Audio (Lip-sync)..... 37
- About AUDIO FOLLOW Function..... 37
- Saving Settings ..... 38
- Making the Settings for Video Fader Operation ..... 39

**Menu Operations and Menu List.....40**

- Menu Operations ..... 40
- Menu List..... 41

**Appendices .....45**

- Main Specifications ..... 45
- Effects List ..... 46
- Calibrating and Changing the Installed Orientation of the Video Fader ..... 56
- About Remote Control..... 58
- Security Slot ..... 58
- Dimensions ..... 58
- Troubleshooting..... 59

**Index .....60**



# About the Power Supply

## Connecting the AC Adapter

Connect the AC adapter as shown in the figure below. Place the AC adapter so the side with the indicator (see illustration) faces upwards and the side with textual information faces downwards.

\* The indicator will light when you plug the AC adapter into an AC outlet.

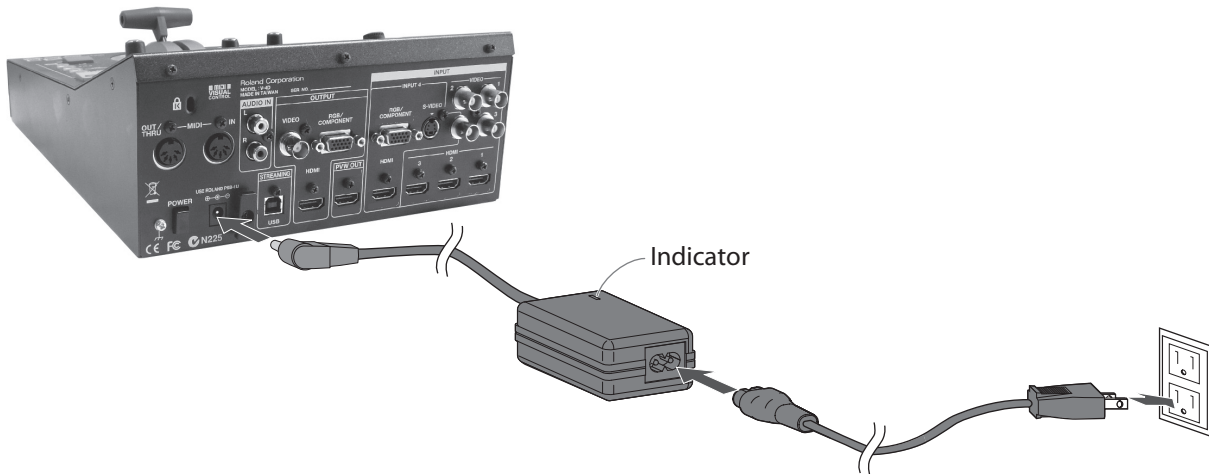

## About the Cord Hook

To prevent the inadvertent disruption of power to your unit (should the plug be pulled out accidentally), and to avoid applying undue stress to the DC IN connector, anchor the power cord using the cord hook, as shown in the illustration.

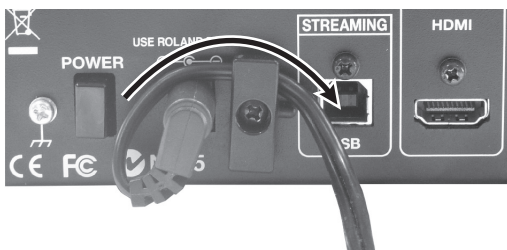

## Caution Regarding the Power Supply

Depending on the circumstances of a particular setup, you may experience a discomforting sensation or perceive that the surface feels gritty to the touch when you touch this device or the metal portions of a video camera, monitor, or other devices connected to it. This is due to an infinitesimal electrical charge, which is absolutely harmless. However, if you are concerned about this, connect the ground terminal (see figure) to an external ground. When the unit is grounded, a slight hum may occur, depending on the particulars of your installation. If you are unsure of the connection method, contact the nearest Roland Service Center or an authorized Roland distributor.

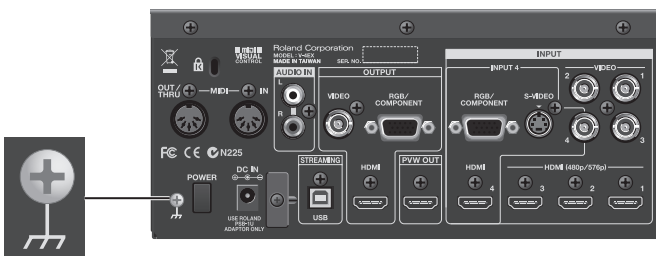

### Unsuitable places for connection

- Water pipes (may result in shock or electrocution)
- Gas pipes (may result in fire or explosion)
- Telephone-line ground or lightning rod (may be dangerous in the event of lightning)

### Turning the Power On and Off

Once everything is properly connected, be sure to follow the procedure below to turn on their power. If you turn on equipment in the wrong order, you risk causing malfunction or equipment failure.

\* This unit is equipped with a protection circuit. A brief interval (a few seconds) after turning the unit on is required before it will operate normally.

#### Turning the Power On

Make sure the power cable is securely inserted, then press the [POWER] button located on the rear panel. The buttons and indicators on the top panel flash, and the V-4EX starts up.



#### Turning the Power Off

Press the [POWER] button on the rear panel. The buttons and indicators on the top panel go dark, and the power to the V-4EX is switched off.

#### About AUTO OFF

When all of the conditions described below continue for 240 minutes or longer, the V-4EX automatically powers down (AUTO OFF feature).

- No operation of the unit (including operation by remote control)
- No video input

To keep the power from being turned off automatically, disable the AUTO OFF feature. You can disable the AUTO OFF feature by going to the [SETUP] menu and setting [AUTO OFF] to [OFF]. Refer to "Menu Operations" (p. 40) and "SETUP Menu" (p. 44).

#### **NOTE**

- Any settings that you are in the process of editing will be lost when the power is turned off. If you have any settings that you want to keep, you should save them beforehand.
- To restore power, turn the power on again.

# Part Names and Functions

## Top Panel

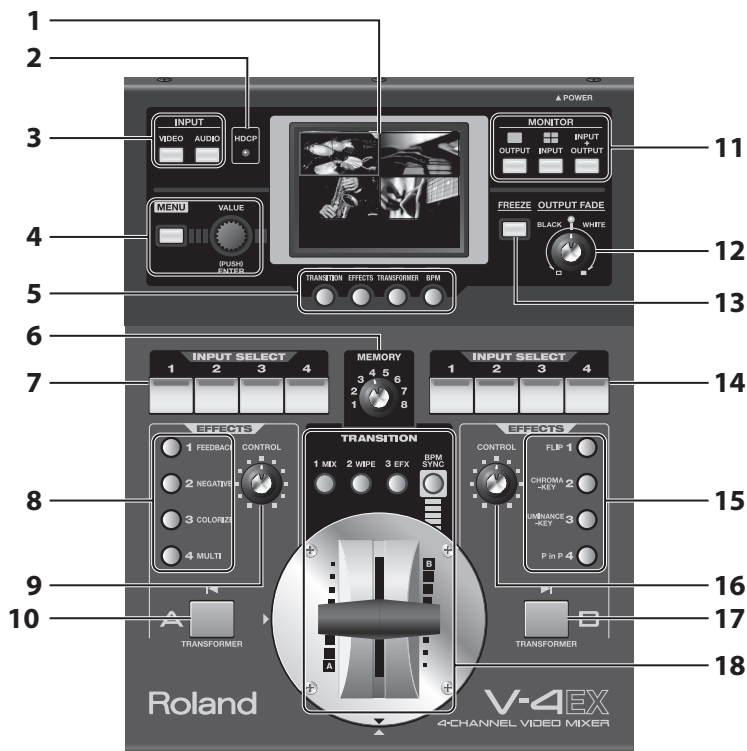

### 1 Monitor

This displays video from source equipment or the video output from the V-4EX. You can select a view mode from below by pressing the MONITOR buttons.

OUTPUT	This displays the current video output from the V-4EX on a single screen.
INPUT	This displays video input from source equipment on a four-way split screen.
INPUT + OUTPUT	This displays the current video output as an inset screen on a four-way split screen displaying the input from source equipment.

You can also use the touch panel to switch the video.

#### NOTE

Note the following points when you switch video using the touch panel.

- Move the video fader all the way to the end of its stroke. The bus of one end is the target for switching. The touch panel cannot be used for switching if the fader has not been moved all the way to one end.
- The touch panel cannot be used for switching while the menu screen is displayed. Exit the menu when you switch using the touch panel.

### 2 HDCP Indicator

This operates as described below, depending on the HDCP setting (p. 24).

Lighted	It lights up when an HDCP-compatible device is connected as the output device.
Flashing	It flashes when no output device is connected or when the connected device is not compatible with HDCP.
Unlighted	It goes dark when the V-4EX's HDCP-signal input/output mode is off.

### 3 INPUT Buttons

Pressing one of these displays the input/output setting screen for video or audio.

VIDEO	This determines the assignments to channels 1 through 4. For each channel, you can select the enabled input connector.
AUDIO	This displays the mixing settings for audio. With the V-4EX, you can output video and audio together (embedded audio) from the HDMI connector and USB port. Use this to perform balance/volume adjustment (p. 36) and set the amount of delay for audio (p. 37).

### 4 MENU Button and VALUE Dial

Use these to display the menu screen and make various settings for the V-4EX (p. 40).

### 5 Setup Buttons

Use these to make the settings for transition effects, filter effects etc. (p. 26).

### 6 MEMORY Dial

You can save the current settings of the V-4EX to the different positions on the dial (p. 37).

\* When [1] has been selected, settings can be changed, but cannot be saved.

### 7 A-bus Input Selectors

These select the channel to be sent to A-bus.

### 8 A-bus Effect Buttons

These apply effects to the video sent to A-bus.

\* By default, from top down, the assigned effects are Strobe, Negative, Colorize, and Multi.

### 9 A-bus Effect Control Dial

This changes the amount of effect applied to the video on A-bus in a smooth and continuous manner.

### 10 A-bus Transformer

Pressing this performs a transition for the video on A-bus. The video on A-bus is displayed while the button is depressed (p. 29).

\* By default, the transition is made using a cut. You can also use menu settings to apply a transition effect.

### 11 MONITOR Buttons

These switch the view mode for the monitor.

### 12 OUTPUT FADE Dial

This applies fade to final output. Turning counterclockwise applies a fade-out to black, and turning clockwise applies a fade-out to white. To apply a fade-in, return the dial to its center position (p. 31).

\* The indicator flashes when the dial is at any position other than center.

### 13 FREEZE Button

This freezes the final output. It lights up while the still video is being output. Pressing the control a second time makes it go dark and ends the output freezing (p. 31).

### 14 B-bus Input Selectors

These select the channel to be sent to B-bus.

### 15 B-bus Effect Buttons

These apply effects to the video sent to B-bus.

\* By default, from top down, the assigned effects are Mirror, Chroma Key, Luminance Key, and Picture-in-Picture.

### 16 B-bus Effect Control Dial

This changes the amount of effect applied to the video on B-bus in a smooth and continuous manner.

### 17 B-bus Transformer

Pressing this performs a transition for the video on A-bus. The video on A-bus is displayed while the button is depressed (p. 29).

\* By default, the transition is made using a cut. You can also use menu settings to apply a transition effect.

### 18 Transition Section

Use this section when switching between the A-bus video and the B-bus video. For information on part names and functions, refer to the following page.

## Transition Section

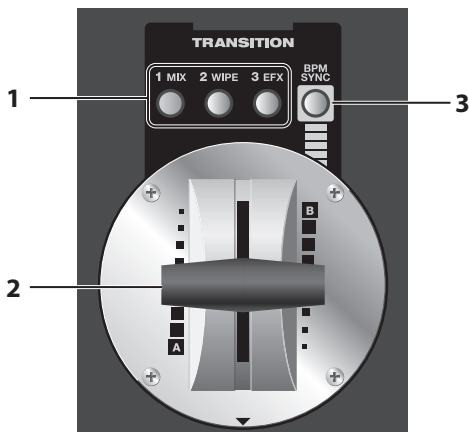

### 1 Transition Effect Buttons

You can assign transition effects to buttons 1 through 3. By default, the following three types are assigned.

1 MIX	The A and B pictures change gradually.
2 WIPE	The A and B pictures change using a wipe.
3 EFX	The A and B pictures change using a soft wipe.

### 2 Video Fader

This has the following three applications.

A/B switching	When no compositing effect is being applied, moving the fader forward or backward switches the video between A-bus and B-bus.
Adjustment of the amount of keying	When you are carrying out chroma or luminance key composition, this adjusts the degree of extraction.
Inset screen display-level adjustment	When you are carrying out Picture-in-Picture composition, this adjusts the display level of the inset screen.

#### MEMO

By default, the video fader is installed vertically (operating front to back), but you can reinstall it horizontally (operating side to side). Refer to "Changing the Installed Orientation of the Video Fader" (p. 57).

### 3 BPM SYNC Button

You can make A/B switching or turning effects on/off to occur in sync with the BPM (beats per minute). Pressing this button to make it light up enables the automatic switching (p. 29).

## Rear Panel

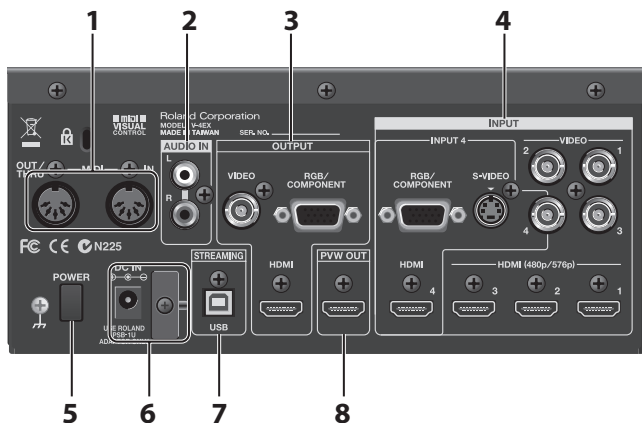

### 1 MIDI IN and OUT/THRU Connectors

Use these when remotely controlling the unit from an external MIDI device (a device compatible with MIDI VISUAL CONTROL or the like), or when using the unit to perform remote control of another device.

### 2 AUDIO IN Connectors

Use these AUDIO INPUT connectors to connect source equipment for analog audio.

### 3 OUTPUT Connectors

These connectors output the results of mixing on the V-4EX. Connect a projector or recording equipment. On the V-4EX, you can output video and audio together (embedded audio) from the HDMI connector and the USB port.

\* You can also use the composite connector (VIDEO) to output four-way split video.

### 4 INPUT Connectors

Connect video source equipment. Sections 1 through 4 are each provided with the connectors below. Use the menus to select the enabled input connector.

INPUT 1 -- 3	Connect composite (VIDEO) or HDMI sources. By default, HDMI input is enabled for each channel.
INPUT 4	In addition to composite or HDMI, you can also connect sources with S-Video or analog RGB (15-pin mini D-Sub type) outputs. By default, HDMI input is enabled.

### 5 POWER Button

This turns the power to the V-4EX on and off.

### 6 DC IN Connector and Cord Hook

These are for connecting the included AC adapter.

### 7 USB Port

When streaming output from the V-4EX or remotely controlling the V-4EX from a computer, use USB cable to make the connection to the computer (p. 20).

### 8 PVW OUT Connector

Connect a monitor for preview output. You can select an output mode from below.

- Four-way split video. Same as [INPUT] mode for the built-in monitor.
- Final video output. Same as [OUTPUT] for the built-in monitor.

\* Output format of the PVW OUT connector is 480/59.94i (when set to NTSC) or 576/50i (when set to PAL).

# Connecting External Equipment

Connect external equipment as shown in this chapter. For information on specific connection methods, refer to the following pages.

\* To prevent malfunction and equipment failure, always turn down the volume, and turn off all the units before making any connections.

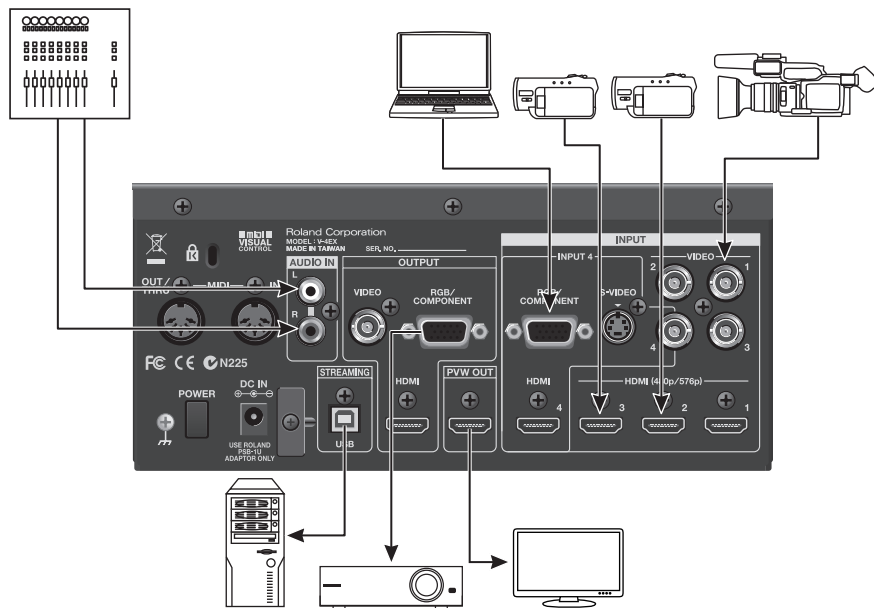

For information on signal formats that can be input and output, refer to "About Input/Output Formats" (p. 23).

## Signal Flow

The internal signal flow of the V-4EX is as shown below.

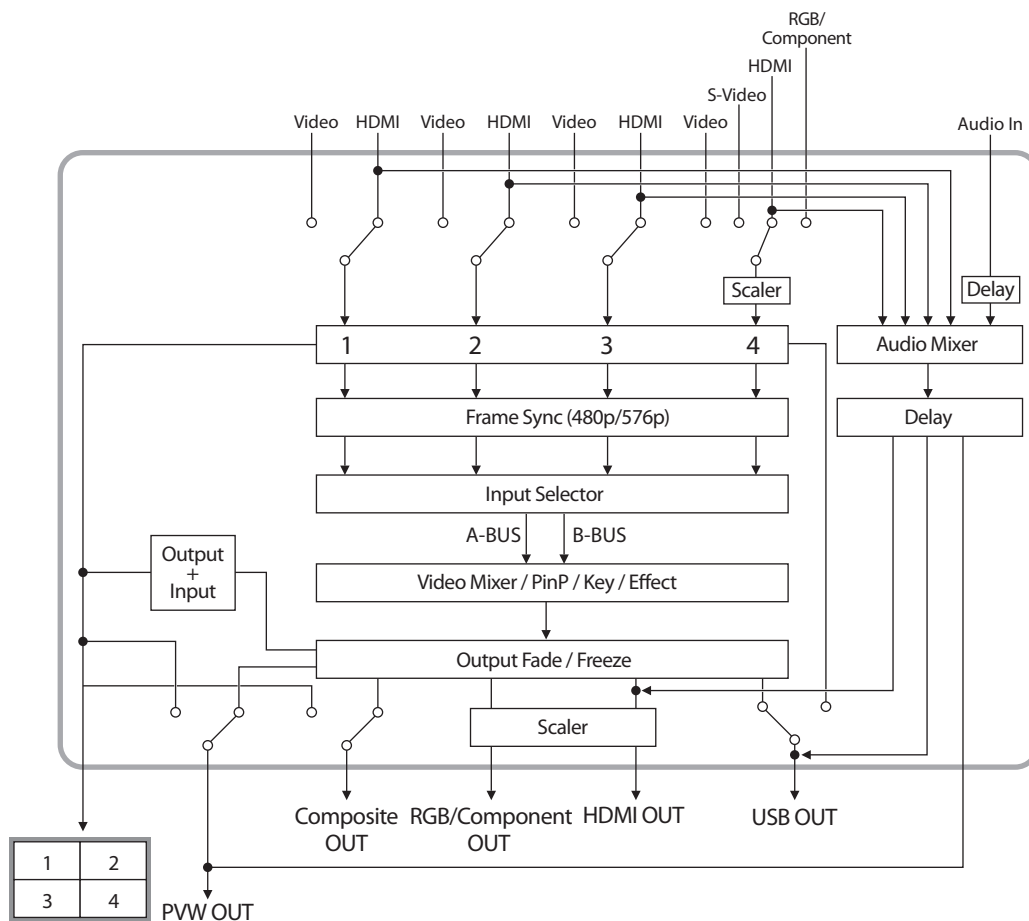

### Connecting Source Equipment

#### NOTE

Regardless of the input resolution of the source device, internal processing by the V-4EX is carried out at 480p (when set to NTSC) or 576p (when set to PAL).

#### NOTE

Almost all equipment capable of HDMI output supports 480/59.94p or 576/50p and can be connected to INPUT 1 through 3 on the V-4EX, but some devices do not support. If the video from such a source device cannot be input correctly via INPUT 1 through 3, connect the device to INPUT 4.

### Connecting Video Source Equipment

#### Making HDMI Connections

Connect video cameras or other devices capable of HDMI output to the [HDMI] connector at INPUT 1 through 4.

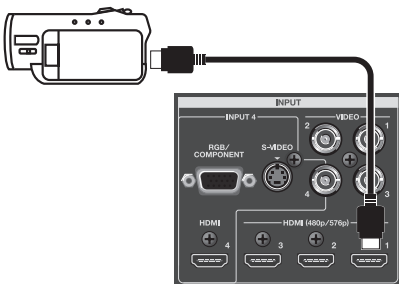

#### Making Composite Connections

Connect video cameras, DVD players, or other devices capable of composite output to the [VIDEO] connectors at INPUT 1 through 4.

\* When connecting equipment that has RCA pin type output connectors, use the included RCA-BNC conversion plug.

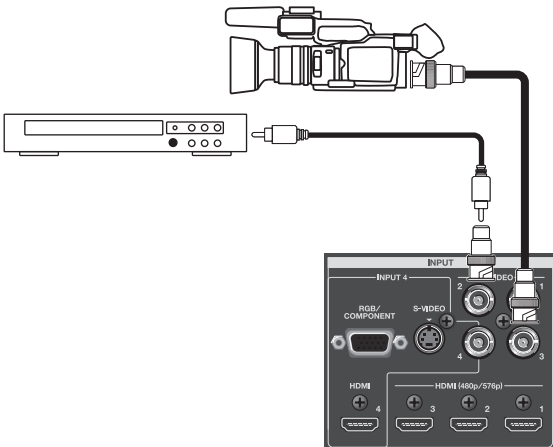

To connect composite source equipment, the enabled connector must be switched from [HDMI] to [VIDEO]. Refer to the following "Switching the Enabled Connector" and change the setting.

#### Making S-Video Connections

You can make an S-Video connection at INPUT 4 only. In the same way as for a composite connection, when making an S-Video connection, the enabled connector must be switched from [HDMI] to [S-VIDEO]. Refer to the following "Switching the Enabled Connector" and change the setting.



## Making an RGB/Component Connection

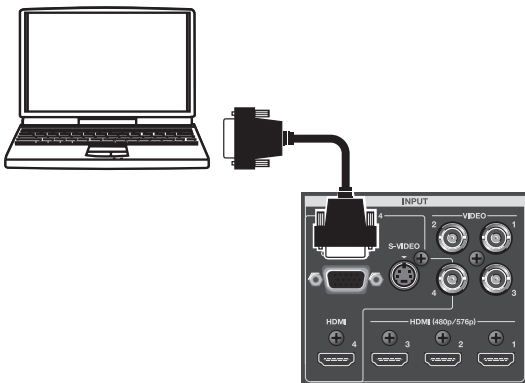

You can make an RGB/component connection at INPUT 4 only. In the same way as for a composite or S-Video connection, the enabled connector must be switched from [HDMI] to [RGB/COMPONENT]. Refer to the following “Switching the Enabled Connector” and change the setting.

\* For equipment provided with component output, make the connection using a conversion cable from component to mini D-Sub 15-pin type connectors.

## Switching the Enabled Connector

Use the procedure described below to enable connectors other than HDMI.

### 1. Display the input setup screen.

Press the [VIDEO] button in INPUT section to display the input setup screen for video.

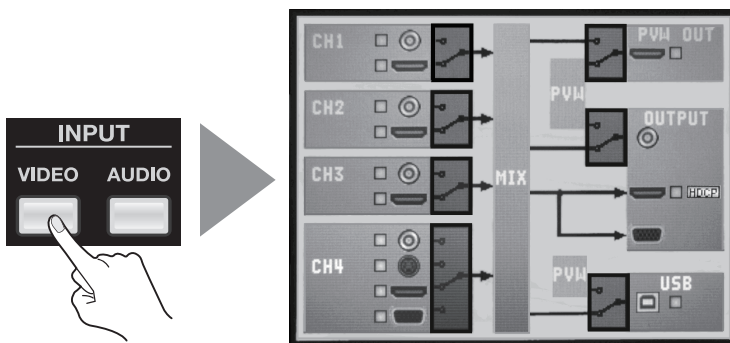

### 2. Select the channel.

Use the touch panel to select the channel where the non-HDMI source is connected.

\* You can also select the channel by turning and pressing the [VALUE] dial.

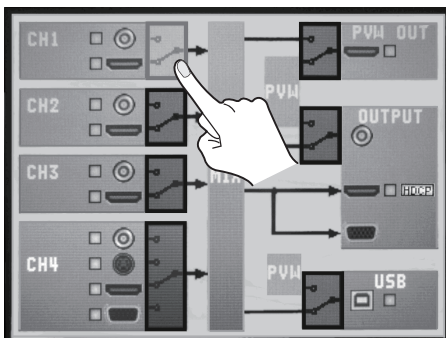

## Connecting External Equipment

### 3. Enable the input.

Turn the [VALUE] dial to change the enabled connector.

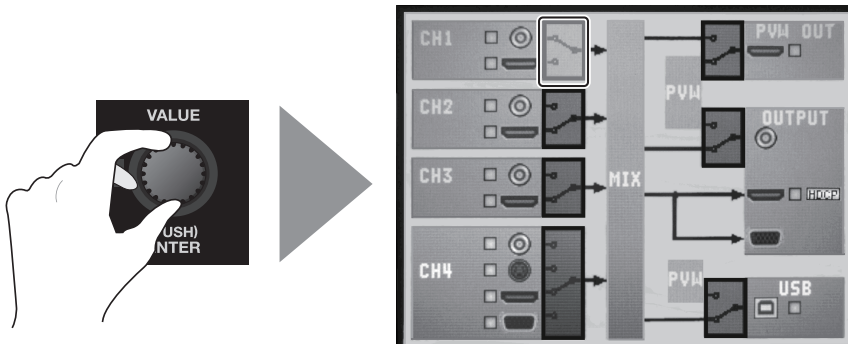

#### MEMO

You can also change the enabled connector using the [VIDEO] button and the input selector buttons of A-Bus. Hold down the [VIDEO] button and press the input selector of the channel you want to change the enabled connector. On channels 1 through 3, switching alternates between HDMI and composite. Channel 4 is switched in this sequence of : composite -> S-Video -> HDMI -> RGB/component.

## Connecting Audio Source Equipment

Connect an audio mixer or other source device to the AUDIO IN connectors. Input made via these connectors is output from the HDMI connectors and the USB port together with the results of video mixing (embedded audio).

\* When connection cables with resistors are used, the volume level of equipment connected to the inputs (AUDIO IN) may be low. If this happens, use connection cables that do not contain resistors.

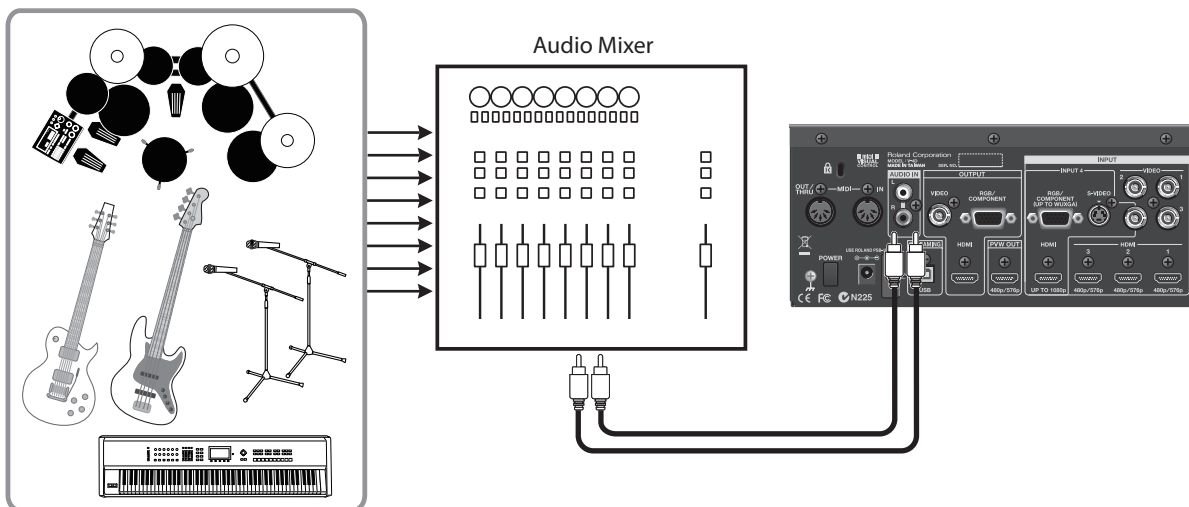

#### MEMO

Use the menus to adjust the balance/volume of the audio output (p. 36) or delay its timing to sync with the video (p. 37).

## Connecting Output Equipment

For information on the signal formats that can be output from the V-4EX, refer to “About Input/Output Formats” (p. 23).

### Connecting a Projector or Recording Unit

Make the connections to the [VIDEO], [RGB/COMPONENT], or [HDMI] output connectors.

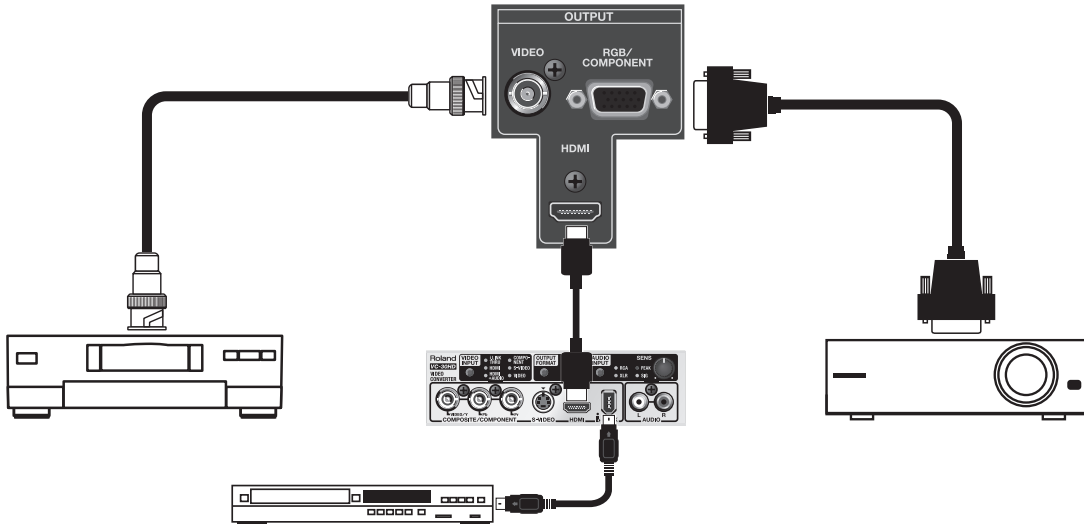

**TIP**

You can connect the VC-30HD to HDMI output. Using the i.LINK output of the VC-30HD, you can connect a digital video recorder, Blu-ray Disc recorder, or other such device.

**NOTE**

When HDCP is turned on, composite and RGB/component output is stopped. Note, however, that HDMI output continues (p. 24).

### Connecting a Preview Monitor

Connect a preview monitor to the PVW OUT connector. Output from this connector is 480/59.94p (when set to NTSC) or 576/50p (when set to PAL). Connect a compatible monitor.

You can select the output mode from below.

- Four-way split video. Same as [INPUT] for built-in monitor.
- Final video output. Same as [OUTPUT] for built-in monitor.

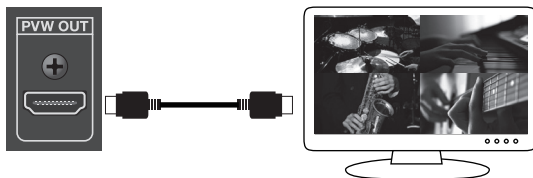

### Connecting a Computer for Streaming

You can send video and audio signals to a computer connected to the USB port.

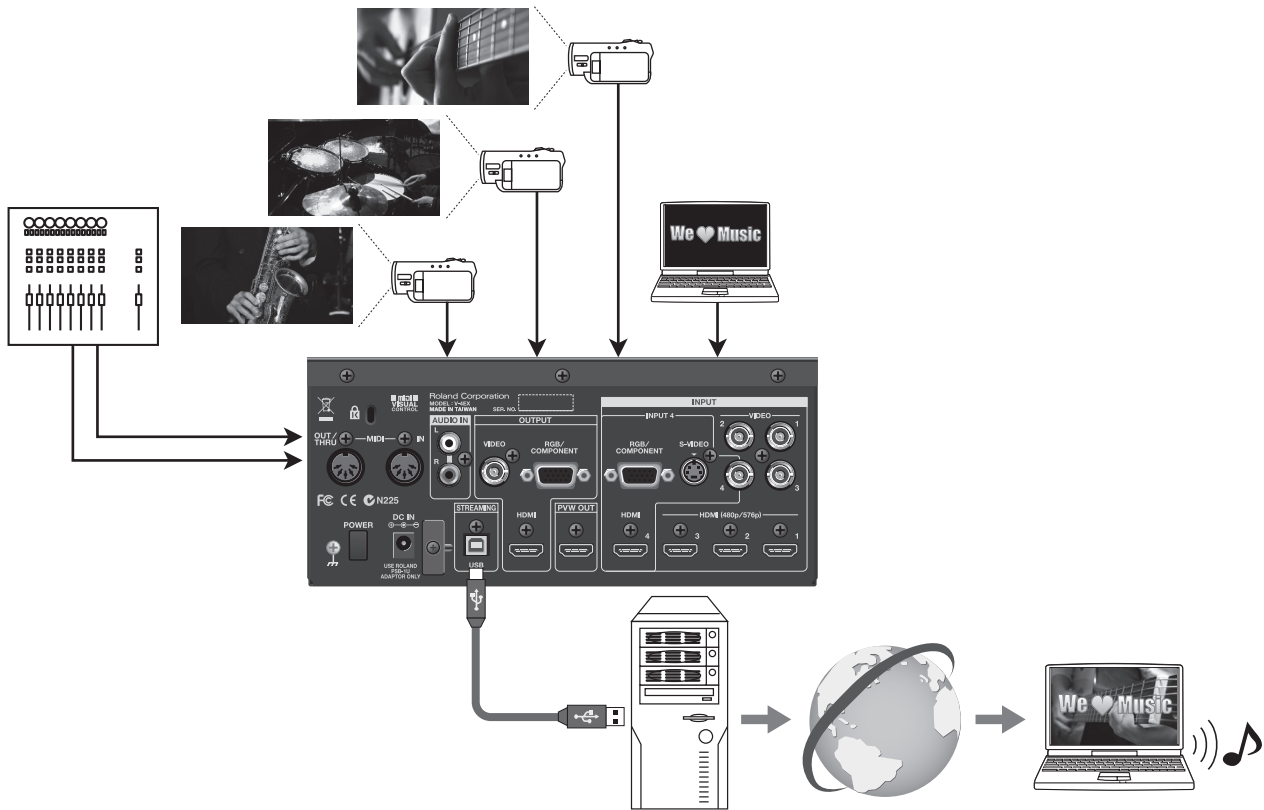

### Supported Operating Systems

Make connections to computers running the following operating systems.

- Windows XP Home Edition/Professional Edition Service Pack 3 or later
- Windows Vista Service Pack 2 or later
- Windows 7
- Mac OS X 10.6 or later

#### **NOTE**

Connection and operation of the V-4EX with standard computers running the operating systems described above have been verified, but connection and operation with all computers satisfying such conditions is not assured. Connection or operation may be impossible due to differences in setting specifications or the usage environment that are specific to the equipment.

## Making the Connection to a Computer

To make the connection to a computer, carry out the steps described below.

### 1. Connect a computer.

After starting the V-4EX and the operating system on the computer, use USB cable to connect the USB port on the V-4EX to a USB port of your computer.

#### **NOTE**

Making the connection through an extension cable or USB hub may result in failure of the computer to detect the V-4EX. We recommend connecting the V-4EX and computer directly.

### 2. Wait for communication between the V-4EX and the computer to be established.

A short while after making the connection, communication with the computer starts, and the standard driver for the operating system is automatically installed. Installing a special driver is not necessary.

\* The computer recognizes the V-4EX as a USB video class device/audio class device.

## Performing Output to a Computer

For the video and audio signals from the V-4EX to be viewed and heard correctly on the computer, software that supports USB video class and USB audio class must be installed and set up on the computer.

### 1. Prepare output of video or audio.

Operate the V-4EX to prepare the video and audio output for the computer.

### 2. On the computer, check the input from the V-4EX.

Start the program that supports USB video class/audio class, and check the video or audio input from the V-4EX.

#### **MEMO**

You can use the menus to adjust the volume/balance of the audio output (p. 36) or delay its timing to sync with the video (p. 37).

## Output Signals

The following signals are output from the USB port on the V-4EX.

Video	720 x 480 pixels (when set to NTSC) or 720 x 576 pixels (when set to PAL)/Motion JPEG
Audio	16 bits/48 kHz/linear PCM

## Checking the Connections

You can check the connections of input and output equipment at the screens described below. To access the checking screens, press the [VIDEO] button or [AUDIO] button in INPUT section.

- \* Depending on the input and output connectors used, some connections cannot be checked.
- \* The checking screen is displayed over the picture on the monitor. You can hide the picture on the monitor by pressing the lighted MONITOR button to make it go dark.

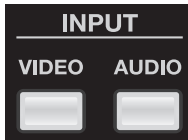

### Video Input/Output Equipment

Pressing the [VIDEO] button in INPUT section displays the screen shown below. A yellow box next to the icon for a connector indicates that the connection is recognized by the V-4EX. If the box is gray, no connection is detected.

- \* The recognition status (grey or yellow) of CH4's S-Video and RGB/Component connectors are displayed only while the connector is selected. When it is not selected, there is no display of box regardless to the recognition status.

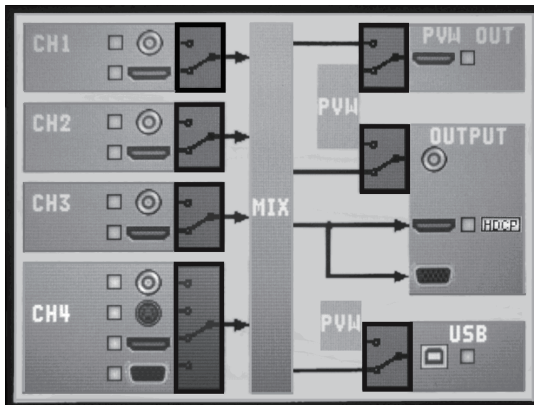

**MEMO**

The [HDCP] indicator is displayed while [HDCP] is turned on and HDCP compatible device is connected.

### Audio Input/Output Equipment

Pressing the [AUDIO] button in INPUT section displays the screen shown below. A yellow box next to the icon for a connector indicates that the connection is recognized by the V-4EX. If the box is gray, no connection is detected.

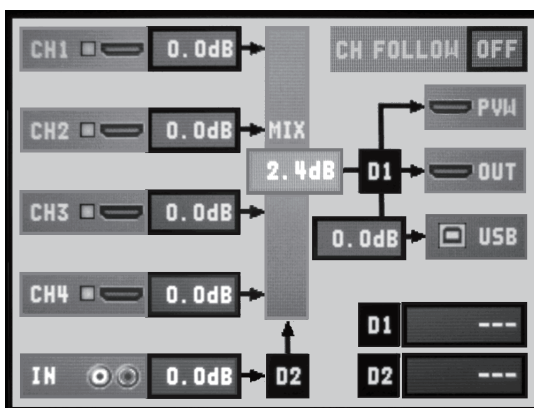

# About Input/Output Formats

## NOTE

Regardless of the input resolution from the source device, internal processing by the V-4EX is carried out at 480p (when set to NTSC) or 576p (when set to PAL). Composite signals (interlaced) are internally converted to progressive signals by the V-4EX. The picture might appear jagged at this time. This is due to progressive conversion, and is not a malfunction.

## Input Formats

The input formats of the connectors are as follows.

### Composite Connectors (INPUT 1 -- 4)

480/59.94i (when set to NTSC), 576/50i (when set to PAL)

### HDMI Connectors (INPUT 1 -- 3)

480/59.94p (when set to NTSC), 576/50p (when set to PAL)

## NOTE

Almost all equipment capable of HDMI output supports 480/59.94p or 576/50p and can be connected to INPUT 1 through 3 on the V-4EX, but some devices do not support. If the video from such a source device cannot be input correctly via INPUT 1 through 3, connect the device to INPUT 4.

## MEMO

When connecting HDMI sources to INPUT 1 through 3 on the V-4EX, set the output format of such devices to 480p (when set to NTSC) or 576p (when set to PAL). If the HDMI device you are using lacks such a setting, set it to "AUTO." If you are using a device that has no output setting, select an SD resolution for shooting/recording.

### HDMI Connector and RGB/COMPONENT Connector (INPUT 4)

480/59.94i (when set to NTSC), 576/50i (when set to PAL)

480/59.94p (when set to NTSC), 576/50p (when set to PAL)

720/59.94p (when set to NTSC), 720/50p (when set to PAL),

1080/59.94i (when set to NTSC), 1080/50i (when set to PAL),

1080/59.94p (when set to NTSC), 1080/50p (when set to PAL)

640 x 480/60 Hz, 800 x 600/60 Hz, 1024 x 768/60 Hz, 1280 x 768/60 Hz, 1280 x 1024/60 Hz, 1366 x 768/60 Hz, 1400 x 1050/60 Hz, 1600 x 1200/60 Hz, 1920 x 1200/60 Hz

\* The refresh rates noted above are the maximum values for the respective resolutions.

### S-Video Connector (INPUT 4)

480/59.94i (when set to NTSC), 576/50i (when set to PAL)

## Output Formats

The output formats of the connectors are as follows.

### Composite Connector

480/59.94i (when set to NTSC), 576/50i (when set to PAL)

### HDMI Connector and RGB/COMPONENT Connector

480/59.94i (when set to NTSC), 576/50i (when set to PAL), 480/59.94p (when set to NTSC), 576/50p (when set to PAL),

720/59.94p (when set to NTSC), 720/50p (when set to PAL), 1080/59.94i (when set to NTSC), 1080/50i (when set to PAL)

640 x 480, 800 x 600, 1024 x 768, 1280 x 768, 1280 x 1024, 1366 x 768, 1400 x 1050, 1600 x 1200, 1920 x 1200

\* The refresh rate for RGB format is 60 Hz at all resolutions when set to NTSC. When set to PAL, the rate is 50 Hz at underlined resolutions and 75 Hz at others.

\* HDMI audio output is 16 bits/48 kHz/linear PCM.

## NOTE

HDMI output and RGB/COMPONENT output always have the same format. Different format cannot be selected independently. When an interlaced output format is selected, component signals are output from the RGB/COMPONENT connector. When a non-interlaced format is selected, RGB signals are output from the RGB/COMPONENT connector.

### PVW OUT Connector

480/59.94p (when set to NTSC), 576/50p (when set to PAL)

### USB Port

720 x 480 pixels (when set to NTSC) or 720 x 756 pixels (when set to PAL)/Motion JPEG

\* USB audio output is 16 bits/48 kHz/linear PCM.

# Inputting HDCP Signals

By default, the HDCP (High-bandwidth Digital Content Protection) setting of the V-4EX is turned off. This means that HDCP-applied signals from Blu-ray Disc players and the like cannot be input. When inputting signals to which HDCP is applied, follow the procedure shown below to change the setting.

\* HDCP is copyright-protection technology that prevents unlawful copying of content by encoding the path when sending digital signals from a video playback device to a display monitor or other display equipment.

## 1. Display the SETUP menu.

Press the [MENU] button to display the menu. Use the touch panel to select [SETUP].



## 2. Change the setting.

Use the [VALUE] dial or the touch panel to select [HDCP]. Turn the [VALUE] dial to change the setting from [OFF] to [ON]. When the confirmation screen appears, press the [VALUE] dial or use the touch panel to confirm the change.

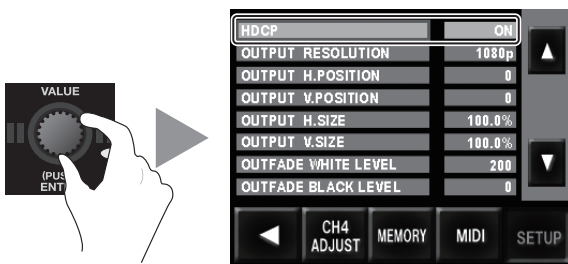

## 3. Exit the menu.

Press the [MENU] button several times to quit the menu.

### NOTE

When the setting change just described has been made, video output from the composite connector, the RGB/COMPONENT connector and the USB port is stopped. Note, however, that HDCP-applied signals are output via the HDMI connector. Preview output also continues.



## About the HDCP Indicator

The [HDCP] indicator on the top panel operates as described below.

- It lights up when an HDCP-compatible device is connected as the output device.
- It flashes when nothing is connected or when the connected device is not compatible with HDCP.
- It goes dark when [HDCP] is set to [OFF].



# Basic Operations



Using this unit makes it possible to create video transitions that occur at extremely high speeds. Depending on physical condition, viewing such video might cause headache or discomfort. Never use this unit to create or present such video that might be distressful to health. Roland assumes no responsibility in the event of any distress experienced by you or other viewers.

## Switching the Monitor View Mode

The V-4EX's built-in monitor has the following three types of view modes. Use the MONITOR buttons to change the mode.

OUTPUT	This displays the current video output from the V-4EX on a single screen.
INPUT	This displays video input from source equipment on a four-way split screen.
INPUT + OUTPUT	This displays the current video output by overlaying it on a four-way split screen displaying the input from source equipment.

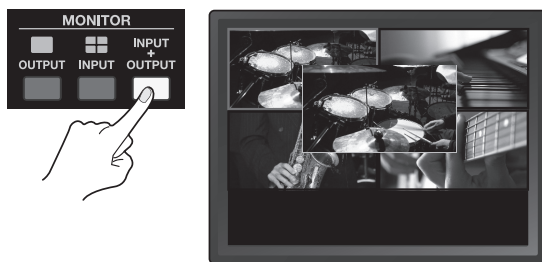
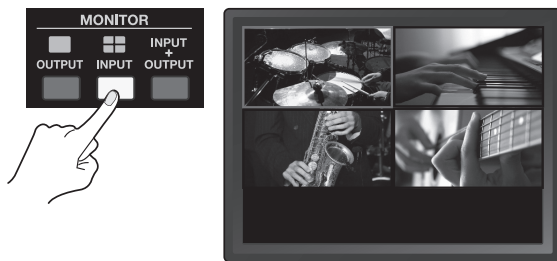
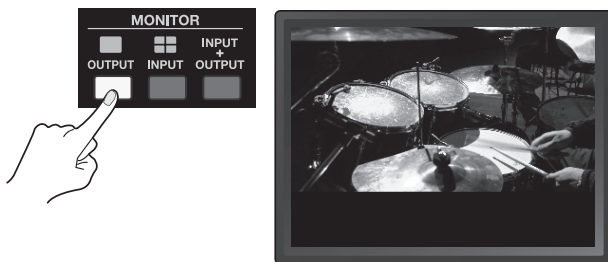

### MEMO

You can select either 16:9 or 4:3 as the aspect ratio for video displayed on the monitor. Go to the SETUP menu (p. 44) and select [LCD PREVIEW ASPECT].

## Changing Various Settings

You can use the buttons under the built-in monitor to access various setup screens.

- \* The screen associated with the pressed button is displayed. The other areas of the monitor display the picture selected by the view mode.
- \* The setup screens are displayed overlaid on the picture on the monitor. You can hide the picture on the monitor by pressing the lighted MONITOR button to make it go dark.



TRANSITION	Press this to change transition effect settings.	p. 27
EFFECTS	Press this to change filter/composition effect settings.	p. 32, p. 33
TRANSFORMER	Press this to assign an effect to a Transformer button.	p. 29
BPM	Press this to change the automatic switching rhythm or to change the output fade mode.	p. 29, p. 31

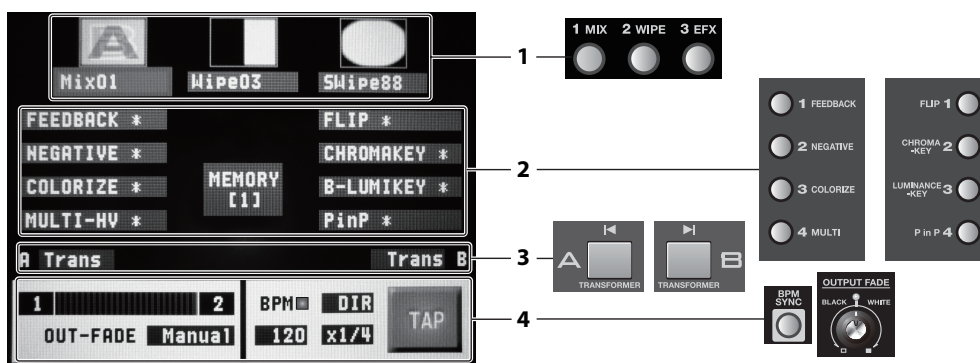

### 1 Transition Effects

Pressing the [TRANSITION] button displays this area. From left to right, these correspond to the [1 MIX], [2 WIPE], and [3 EFX] buttons.

Use the touch panel to choose the transition effect (1 through 3) whose settings you want to change, and turn the [VALUE] dial to select the transition effects assigned to the respective buttons.

### 2 Filter/Compositing Effect

Pressing the [EFFECTS] button displays this area. The left side corresponds to Effect buttons 1 through 4 for A-Bus, and the right side corresponds to Effect buttons 1 through 4 for B-Bus.

Use the touch panel to choose the Effect (A1 through A4 or B1 through B4) whose settings you want to change, and turn the [VALUE] dial to select the filter/composition effects assigned to the respective buttons.

### 3 Transformer

Pressing the [TRANSFORMER] button displays this area. It corresponds to the A-Bus and B-Bus Transformers.

Use the touch panel to choose the bus (A or B) where you want to assign a transition effect, and turn the [VALUE] dial to select the transition effect to assign.

### 4 BPM

Pressing the [BPM] button displays only this area.

For detailed information on BPM, refer to "Switching Automatically in Time with the Musical Rhythm" (p. 29).

This area displays the following information.

- Channel selected for A-Bus/B-Bus
- Position of the video fader
- Output fade mode

## Switching the Video

### Switching the Picture Using the Video Fader

#### 1. Check which channels are currently selected.

Before you carry out a transition operation, check which channels are currently selected. At powerup of the V-4EX, channel 1 is selected for the A-Bus input selectors, and channel 2 is selected for the B-Bus input selectors. The bus corresponding to the end to which the video fader has been moved is output, and when the built-in monitor is in the INPUT mode, a red border is displayed around the output picture. A green border is displayed around the picture on the opposite bus (the standby video).

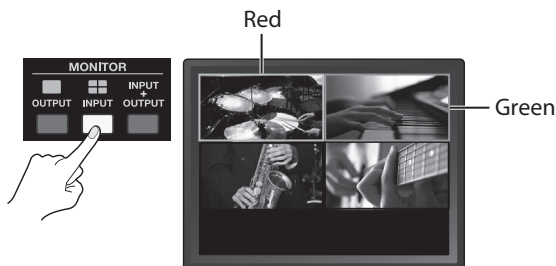

**MEMO**

When the pictures on A and B are output simultaneously, such as during the application of a transition effect or a compositing effect, red borders are displayed around both pictures.

#### 2. Select a transition effect.

Use the transition effect buttons to select the transition effect you want to apply. By default, you can select from below.

1 MIX	The pictures on A and B change gradually.
2 WIPE	The pictures on A and B change using a wipe.
3 EFX	The pictures on A and B change using a soft wipe.

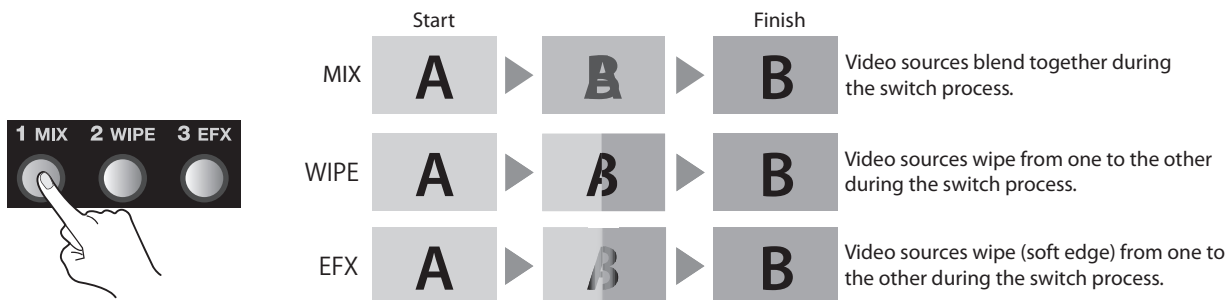

**MEMO**

To assign other transition effects to 1 through 3, press the [TRANSITION] button to access the setup screen.

#### 3. Select the channel on the opposite bus.

On the opposite bus, select the channel you want to output next. The indicator for the selected channel lights up green.

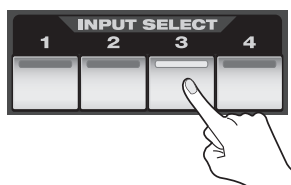

### 4. Switch between the A-Bus and the B-Bus.

Move the video fader to the end for the bus of the channel you selected in step 3. The transition effect you selected in step 2 is applied, and the output picture is switched.

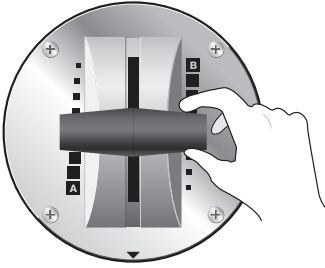

## Switching Using the Touch Panel

### 1. Change the monitor's view mode to INPUT.

Press the MONITOR [INPUT] button to change the view mode to the INPUT mode. The display changes to a four-way split screen.

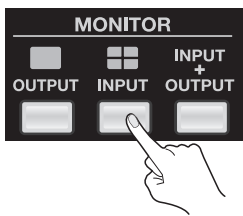

### 2. Select the bus.

Move the video fader all the way to the A-Bus end or the B-Bus end.

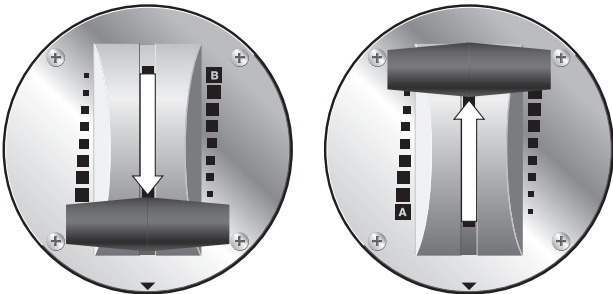

### 3. Use the touch panel to make the switch.

Touch the monitor to select the output picture. When you do this, a red border appears around the picture being output. The input selector for the bus you selected in step 2 also lights up.



### NOTE

Note the following points when you switch video using the touch panel.

- Move the video fader all the way to the end of its stroke. The bus of one end is the target for switching. The touch panel cannot be used for switching if the fader has not been moved all the way to one end.
- The touch panel cannot be used for switching while the menu screen is displayed. Exit the menu when you switch using the touch panel.

## Switching Using the Transformer Buttons

**1. Select the channel on the opposite bus.**

On the opposite, select the channel you want to output next. The indicator for the selected channel lights up.

**2. Use the Transformer buttons to switch the picture.**

Press the Transformer button for the bus of the channel selected in step 1. The output picture is switched using a cut.

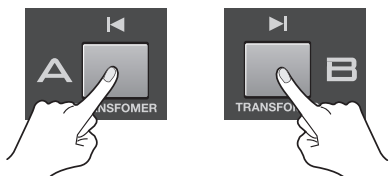

**3. Return to the output on the original bus.**

Releasing the Transformer button returns the output to the picture on the original bus.

**MEMO**

To assign a transition effect to a Transformer button, press the [TRANSFORMER] button to access the setup screen.

## Switching Automatically in Time with the Musical Rhythm

Pressing the [BPM SYNC] button to make it light up causes automatic switching between A and B.

\* Press the [BPM SYNC] button again and make it go dark to stop the automatic switching.

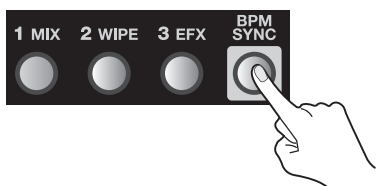

Use this feature when you want to perform switching on the rhythm of background music. By default, switching is performed at 120 BPM (beats per minute). You can use either of the following two methods to change the BPM setting.

### Setting the BPM by Tapping

At times such as when the BPM value of the music is not known, set the BPM by tapping the screen with your finger.

**1. Access the BPM setup screen.**

Press the [BPM] button to access the BPM setup screen.

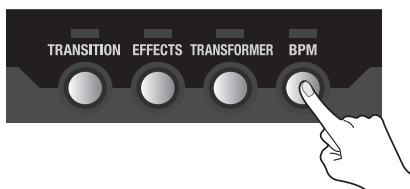

**2. Tap on the rhythm of the music.**

Tap the on-screen [TAP] button on the rhythm of the background music. Tap several times to set the BPM value. The BPM indicator starts to flash according to the BPM.



**3. Exit the BPM setup screen.**

Press the [BPM] button again to quit the setup screen.

### Setting the BPM Numerically

If you know the BPM value of the music, you can set the numerical value directly.

**1. Access the BPM setup screen.**

Press the [BPM] button to access the BPM setup screen.

**2. Change the value for BPM.**

Select the BPM value area (set at "120" by default) to select it. Turn the [VALUE] dial to change the value.

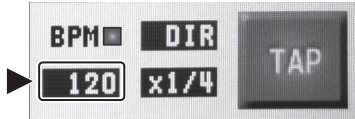

**3. Exit the BPM setup screen.**

Press the [BPM] button again to quit the setup screen.

### About the Automatic Switching Mode

You can select either of the following two modes by selecting the area where [DIR] or [TRANS] is displayed and turning the [VALUE] dial.

DIR	This means direct. The picture is switched using a cut.
TRANS	This is the default setting and means transition. The picture is switched with the currently selected transition effect applied.

You can select the speed of automatic switching by selecting the area where numeric like [x1/4] or [x1/2] is displayed and turning the [VALUE] dial.

x1/4	The picture is switched at quarter speed of the currently set BPM.
x1/2	This is the default setting. The picture is switched at half speed of the currently set BPM.
x1	The picture is switched at the same speed as the currently set BPM.
x2	The picture is switched at doubled speed of the currently set BPM.

## Applying Fade to Final Output

You can use the [OUTPUT FADE] dial to apply a fade to the V-4EX's final output. Applying a fade makes the output video gradually disappear (fade-out) or appear (fade-in). Turning the dial counterclockwise applies a fade-out to black, and turning it clockwise applies a fade-out to white. The indicator above the dial flashes while the fade is being applied. Returning the dial to its center position makes the indicator light up continuously and returns the unit to 100% output.

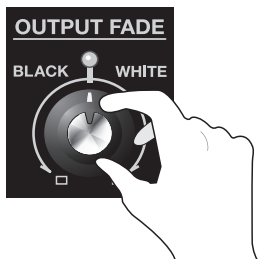

### About the Output Fade Modes

You can select a mode from below by selecting the [OUT-FADE] area of BPM setting screen and turning the [VALUE] dial.

Manual	This is the default setting. Apply a white or black fade by turning the dial.
Auto	A fade-in/fade-out is repeated automatically. The speed varies according to the position of the dial.
No Ctrl	Dial operation is disabled.

## Freezing the Final Output

You can stop (freeze) the video being output. Pressing the [FREEZE] button freezes the picture being output and makes the button light up. Press the button again to end the freezing.



## About AUTO SCAN Function

Press the [MENU] button and turn on [AUTO CHANNEL SCAN] in SETUP menu. The V-4EX switches channels 1 through 4 automatically. You can also set the following parameters.

- AUTO SCAN TIME You can set the interval of channel switching.
- AUTO TRANSITION TIME You can set the time of transition effect that is applied while switching.

\* The V-4EX skips the channel where no video signal is input.

# Applying Filter Effects to Video

You can apply filter effects to the video on A-Bus by using the A-Bus Effect buttons. By default, the following filter effects are assigned to 1 through 4.

FEEDBACK	This repeats layering of the picture upon itself.
NEGATIVE	This inverts the colors or brightness levels of the picture.
COLORIZE	This effect adds color to the picture, producing a painting-like feel.
MULTI	This splits the screen and reduces the size of the pictures.



## MEMO

You can display a screen for assigning other effects by pressing the [EFFECTS] button.

### 1. Output the video to which you want to apply an effect.

Select and output the A-Bus channel you want to apply an effect.

### 2. Select the effect to apply.

Use the A-Bus Effect buttons to select the effect to apply.

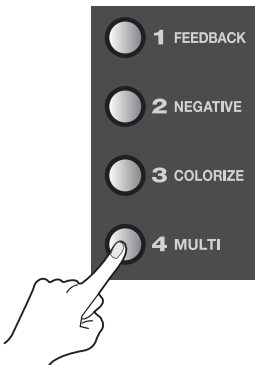

### 3. Adjust the amount of effect.

Turn the A-Bus Effect Control dial to adjust the amount of effect.

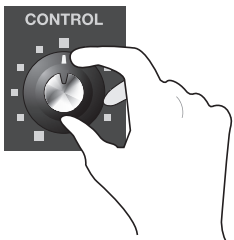

The default filter effects change as follows when you turn the Effect Control dial.

FEEDBACK	Turning the control clockwise shortens the repeating interval.
NEGATIVE	Turning the dial clockwise cycles through these settings: brightness inversion -> color inversion -> brightness and color inversion.
COLORIZE	The colorization pattern varies according to the position of the dial.
MULTI	Turning the dial clockwise increases the number of screen divisions.

## MEMO

By default, in addition to the four types of filter effects just described, [FLIP] is assigned to a B-Bus Effect button. When using this effect, select the video on B-Bus. Pressing the B-Bus [FLIP] Effect button applies the flip effect. Also, to adjust the parameter of effect (or to change the direction of screen flipping), use the B-Bus Effect Control dial.



# Compositing Two Pictures

Use the compositing effects described below to composite (combine) two pictures. By default, these effects are assigned to B-Bus Effect buttons 2 through 4.

CHROMA-KEY	This extracts (blanks out) blue or green areas in the foreground picture and composites with the background picture. By default, blue areas are extracted.
LUMINANCE-KEY	This extracts black or white areas of the foreground picture and composites with the background picture. By default, black areas are extracted.
PinP (Picture-in-Picture)	This reduces the size of the foreground picture and composites with the background picture as an inset screen.



## Key Compositing

You can use the KEY menu (p. 41) to change settings like the extraction color for chroma key or luminance key.

### Compositing Using Chroma Key

Using chroma key, you can composite video that has a blue or green background. Blue is extracted by default..

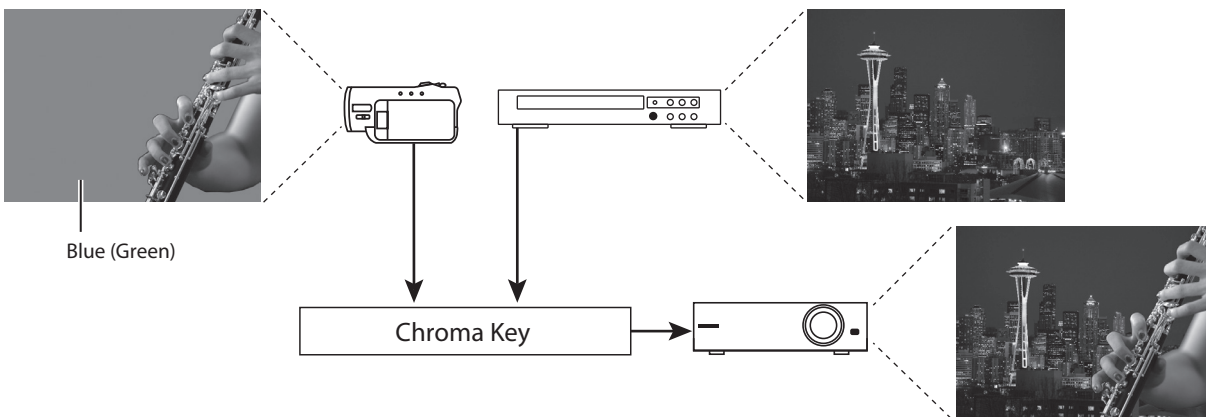

#### 1. Choose the background picture.

Use the A-Bus input selectors to select the channel of the background.

#### 2. Select the video to display in the foreground.

Use the B-Bus input selectors to select the channel of the video to be displayed in foreground.

#### 3. Perform compositing.

Press the B-Bus [CHROMA-KEY] Effect button to make it light up.

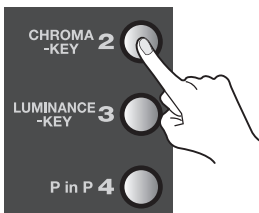

## Compositing Two Pictures

### 4. Adjust the amount of keying.

Turn the B-Bus Effect Control dial to adjust the amount of keying.

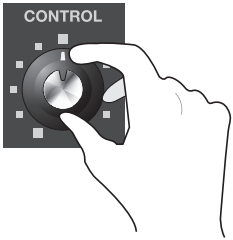

### 5. Adjust the level of the foreground video.

You can adjust the display level of the foreground video by moving the video fader forward or backward. Moving it all the way to the B-Bus end displays the foreground video at a level of 100%. Moving it all the way to the A-Bus end makes the foreground video disappear.

## Compositing Using Luminance Key

Using luminance key, you can superimpose logos or text on a background picture. You can connect RGB output from a computer to INPUT 4 and composite with video. By default, black is extracted.

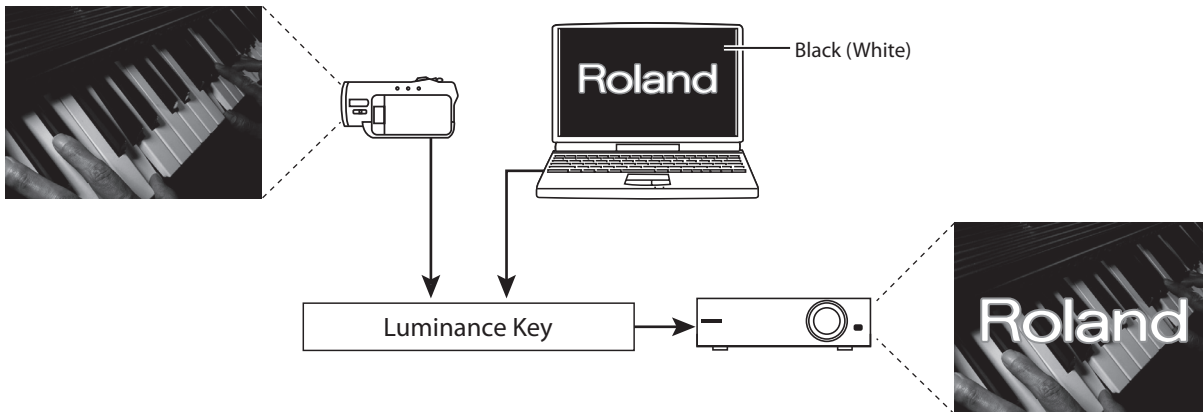

### 1. Choose the background picture.

Use the A-Bus input selectors to select the channel of the background.

### 2. Select the video to display in the foreground.

Use the B-Bus input selectors to select the channel to be displayed in the foreground. To composite a logo or text input from a computer, select [4].

\* Enable the input connector where the computer is connected.

### 3. Perform compositing.

Press the B-Bus [LUMINANCE-KEY] Effect button to make it light up.

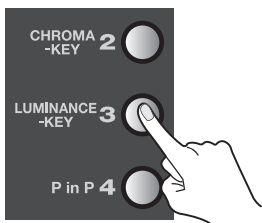

### 4. Adjust the amount of keying.

Turn the B-Bus Effect Control dial to adjust the amount of keying.

### 5. Adjust the level of the foreground video.

You can adjust the display level of the logo or text by moving the video fader forward or backward. Moving it all the way to the B-Bus end displays the logo or text at a level of 100%. Moving it all the way to the A-Bus end makes the logo or text disappear.

## Compositing Using Picture-in-Picture

Compositing that overlays an inset screen on a background is called “Picture-in-Picture” (PinP).

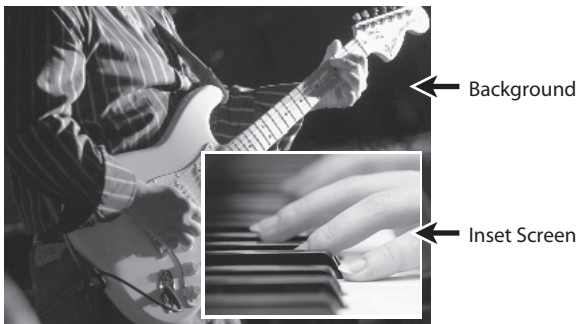

### 1. Choose the background picture.

Use the A-Bus input selectors to select the channel of the background.

### 2. Select the video to display as the inset screen.

Use the B-Bus input selectors to select the channel to be displayed as the inset screen.

### 3. Perform compositing.

Press the B-Bus [P in P] Effect button to make it light up.

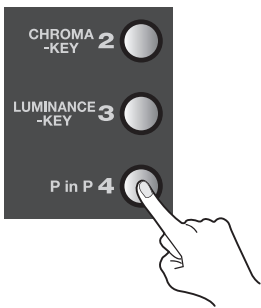

### 4. Change the size of the inset screen.

Turn the B-Bus Effect Control dial to change the size of the inset screen.

\* Turning the dial sequentially recalls the PinP 1 through 8 settings.

### 5. Change the position of the inset screen.

Press the [OUTPUT] MONITOR button to display the composited results on the built-in monitor. You can change the position of the inset screen by sliding your finger on the touch panel.

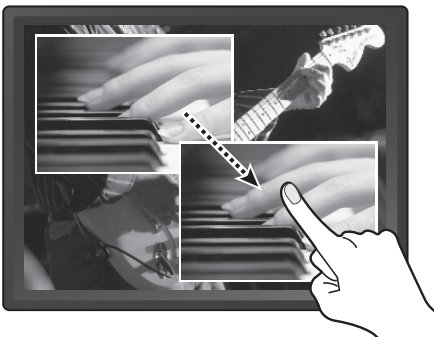

### 6. Adjust the display level of the inset screen.

You can adjust the display level of the inset screen by moving the video fader forward or backward. Moving it all the way to the B-Bus end displays the inset screen at a level of 100%. Moving it all the way to the A-Bus end makes the inset screen disappear.

#### MEMO

You can also use the PinP menu (p. 42) to make settings for the position and size of the inset screen. You can save up to eight sets of settings at the PinP menu (EFFECTS 140 through 147). To save settings, press the [MENU] button to display the menu, then press the on-screen [PinP 1 - 4] or [PinP 5 - 8] button. Selecting [SAVE CURRENT PinP] lets you save the current settings to the corresponding number.

# About Other Features

## Adjusting the Audio Balance/Volume

On the V-4EX, you can output video and audio together (embedded audio) from the HDMI connector and the USB port. Using the procedure in this chapter, you can adjust the balance of analog audio (1 stereo) input via the AUDIO IN connectors and audio (4 stereo) input via HDMI. After that, you can also adjust the output volume.

### MEMO

The results of balance/volume adjustment are applied to the audio output via HDMI and USB. Carry out balance/volume adjustment while monitoring the sound via connected monitor speakers or the computer's speakers.

#### 1. Display the audio setup screen.

Press the [AUDIO] button in the INPUT section to display the setup screen for audio.

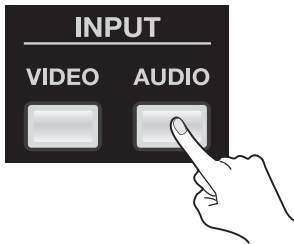

#### 2. Adjust the balance for each channel.

Use the touch panel to select from among [CH 1] to [CH 4] or [IN], then turn the [VALUE] dial to raise or lower the level.

\* [CH 1] through [CH 4] correspond to HDMI inputs 1 through 4. [IN] corresponds to analog input.

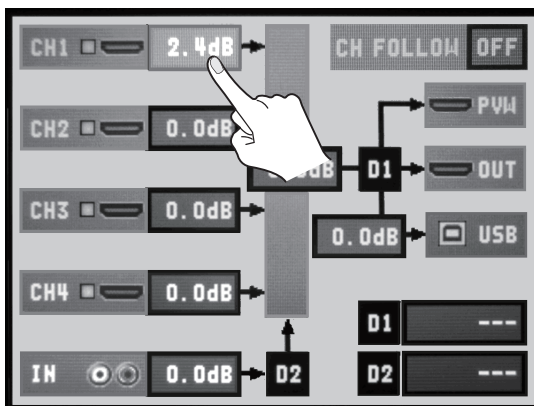

#### 3. Adjust the volume of the final output.

Use the touch panel to select [MIX], then turn the [VALUE] dial to raise or lower the level.

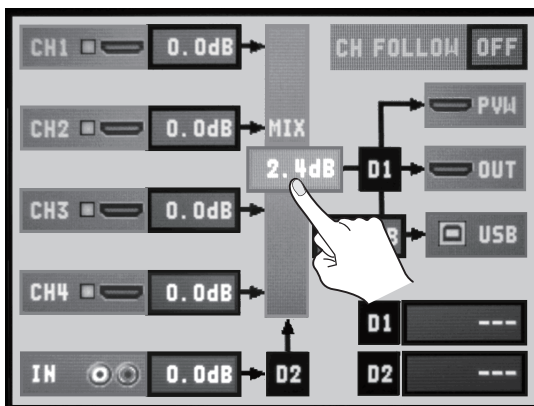

#### 4. Close the setup screen.

Press the [AUDIO] button in the INPUT section again to return to the original screen.

### MEMO

You can mute/unmute the sound by holding down the [AUDIO] button in INPUT section and press an input selector. The A-Bus input selectors (1 through 4) correspond to channels 1 through 4. B-Bus input selectors [1] corresponds to AUDIO IN. B-Bus input selector [4] corresponds to the output. Each press mutes/unmutes the sound of the corresponding channel. The output switches between mute and the currently set output level.

## Aligning the Timing of Video and Audio (Lip-sync)

You can use the procedure described below to apply delay to audio and align the video/audio timing.

### 1. Display the audio setup screen.

Press the [AUDIO] button in the INPUT section to display the setup screen for audio.

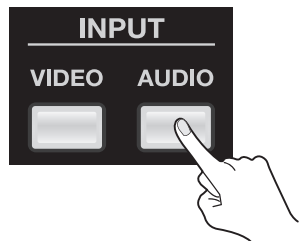

### 2. Adjust the amount of delay.

Use the touch panel to select [D1] or [D2], then operate the [VALUE] dial to adjust the amount of delay.

- \* [D1] is delay applied globally to the output, and [D2] is delay applied only to AUDIO IN input.
- \* You can set [D1] in a range of 0.0 to 4.0 frames and [D2] in a range of 0.0 to 2.0 frames.

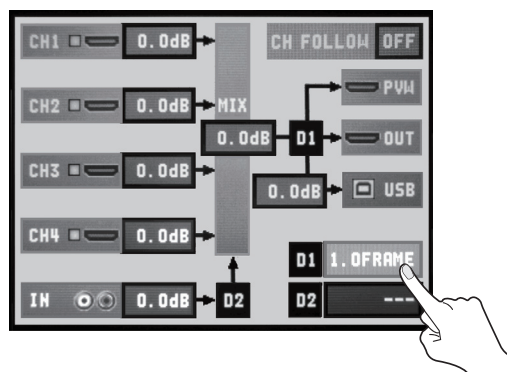

### 3. Close the setup screen.

Press the [AUDIO] button in the INPUT section to return to the original screen.

## About AUDIO FOLLOW Function

The V-4EX automatically increases the level of same audio channel when you switch video channel (1-4) if the [CH FOLLOW] is turned on. In this case, the audio outputs of other channels are muted.

- \* AUDIO IN level can follow switching video channel 4.

# Saving Settings

The MEMORY dial on the V-4EX has positions from [1] to [8]. You can save the button and dial settings described below to [2] through [8].

- Effects assigned to A-Bus and B-Bus Effect buttons
- Settings of the A-Bus and B-Bus TRANSFORMER buttons
- Effects assigned to transition buttons (MIX/WIPE/EFX)
- The BPM SYNC setting
- The setting of the OUT FADE dial

### NOTE

When [1] has been selected, settings can be changed, but not saved.

#### 1. Select the number to save to.

Turn the MEMORY dial to select a number from [2] to [8] as the destination for saving.

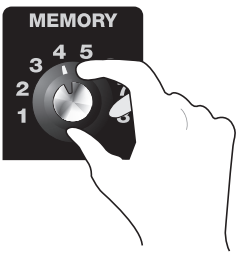

#### 2. Change the setting.

Refer to “Menu Operations and Menu List” (p. 40) to change the settings for the buttons and dials. When you close the menu screen, they are saved at the number you selected in step 1.

#### 3. Return the unit to its factory-default state.

Turning the MEMORY dial to [1] returns the unit to its factory-default state.

## Copying/Exchanging/Protecting Settings

You can take settings saved at a number from [2] to [7] and copy them to a different number or exchange (swap) them with the values saved at another number. You can also protect the values saved at a specific number.

\* Before carrying out this operation, turn the MEMORY dial to access the number whose settings you want to copy, exchange, or protect.

### Copy

Press the [MENU] button and use the MEMORY menu (p. 43) to select [COPY]. Turn the [VALUE] dial to select the copy-destination number, then press the [VALUE] dial to execute the copy operation.

\* Selecting [ALL] as the copy destination copies the current settings at all numbers except [1].

### Exchange

Press the [MENU] button and use the MEMORY menu to select [EXCHANGE]. Turn the [VALUE] dial to select the exchange-destination number, then press the [VALUE] dial to execute the exchange.

### Protect

Press the [MENU] button and use the MEMORY menu to select [PROTECT]. When this is set to [ON], settings cannot be rewritten.

### NOTE

MEMORY [1] cannot be selected for copying, exchange.

## Making the Settings for Video Fader Operation

### Operation Mode of the Video Fader

When video is switched using the Transformers or [BPM SYNC], situations might occur in which the position of the video fader does not match the actual output. Selecting [QUICK] as the operation mode lets you make the actual output match the position of the video fader instantly when you move the fader. Note, however, that when [QUICK] has been selected, the output video might change suddenly. To avoid such sudden changes, use the unit with the [NORMAL] setting.

- **NORMAL** This is the default setting. The picture does not change until the position of the video fader matches the actual output.
- **QUICK** The actual output immediately changes to match the video fader position the instant you move the fader.

To change the operation mode for the video fader, go to the SETUP menu (p. 44) and change the setting for [FADER MODE].

### Video Fader Operating Curve

You can select one from three types of operating curves below.

- **Curve A** This is the default setting. The entire stroke of the video fader is used to perform A/B switching.
- **Curve B** Response is more sensitive at the center of the stroke. Response at either end is less sensitive.
- **Curve C** Only the center of the stroke is effective. The ends are completely unresponsive.

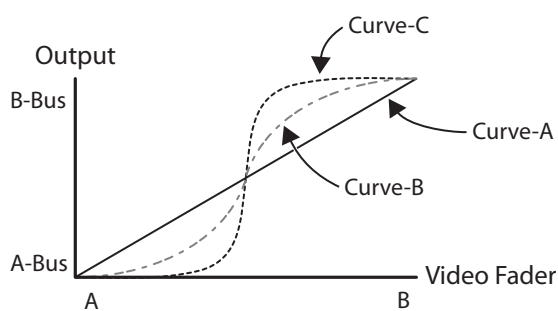

To change the operating curve of the video fader, go to the SETUP menu (p. 44) and change the setting for [FADER CURVE].

# Menu Operations and Menu List

## Menu Operations

Use the [MENU] button and the [VALUE] dial, or the touch panel on the built-in monitor, to make various settings.

### 1. Access the menu.

Display the menu screen on the built-in monitor by pressing the [MENU] button. Displayed first is the top menu. From here, you can access the setup screens for various items.

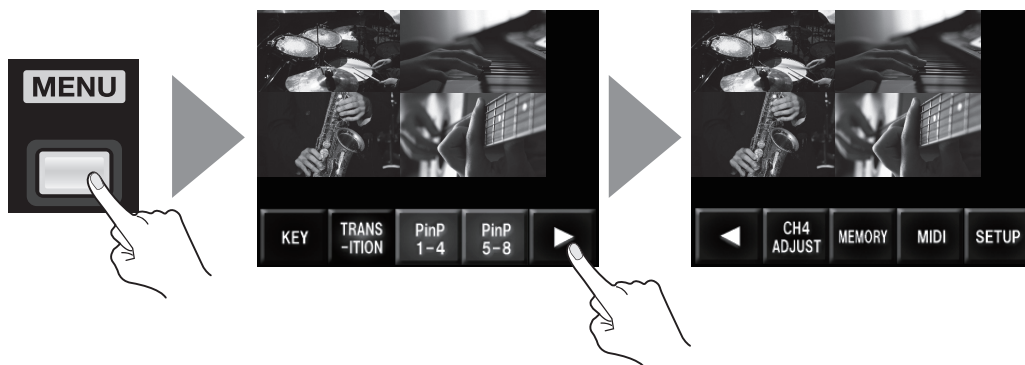

### TIP

When all MONITOR buttons (OUTPUT, INPUT, and INPUT + OUTPUT) are dark, input and output video is hidden and only the menus are displayed. When you want to display only the menus and hide the video, press the currently lighted button to make it go dark.

### 2. Select the item to set.

Select the item to set by turning and pressing the [VALUE] dial or by using the touch panel on the built-in monitor. A list of the items is displayed. If you do not find the item you want to set on the first page, you can use the left and right cursor buttons or the [VALUE] dial to scroll the displayed pages.

### 3. Select a parameter.

Select a parameter by turning and pressing the [VALUE] dial or by using the touch panel on the built-in monitor. If the parameter cannot be displayed on just one page, you can use the [VALUE] dial or the up and down buttons to scroll through them.

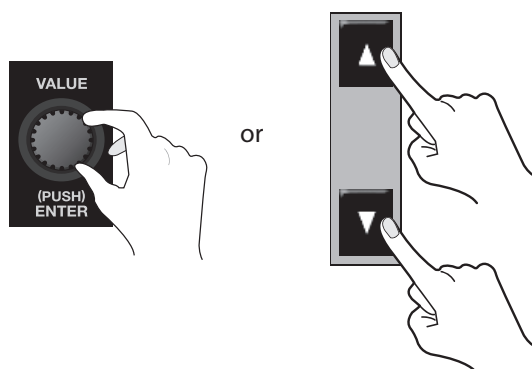

### 4. Change and apply the setting value.

Change the setting value by turning the [VALUE] dial, then apply the value by pressing the dial.

### 5. Go back to the original screen.

Press the [MENU] button several times to go back to the original screen.

### NOTE

The settings of the menu items are saved to the internal memory when the menu disappears and you return to the original screen. Turning off the power while the menu is displayed causes any settings that have been made to be lost.



## Menu List

\* Display setting values shown enclosed in square brackets (“[ ]”) are factory-default values.

### KEY Menu

WHITE LUMI KEY LEVEL	0 - [128] - 255	This specifies the degree of white-key extraction.
WHITE LUMI KEY EDGE	1 - [14] - 15	This specifies the degree of edge blur for white-key extraction.
BLACK LUMI KEY LEVEL	0 - [128] - 255	This specifies the degree of black-key extraction.
BLACK LUMI KEY EDGE	1 - [14] - 15	This specifies the degree of edge blur for black-key extraction.
CHROMA KEY COLOR	BLUE-MGNT, [BLUE-CYAN], RED-MGNT, RED-YELW, MGNT-RED, MGNT-BLUE, CYAN-GREN, GREN-CYAN, GREN-RED, CYAN-BLUE, YELW-GREN, YELW-RED	This specifies the extraction color for chroma key.
CHROMA KEY LEVEL	0 - [128] - 255	This specifies the degree of extraction for chroma key.
CHROMA KEY EDGE	1 - [14] - 15	This specifies the degree of edge blur for chroma key.
SILHOUETTE LEVEL	0 - [128] - 255	When you are using Silhouette (Effect No. 052 -- 060), this specifies the threshold value of the area between the light and dark areas of the picture.

### TRANSITION Menu

This specifies a user transition (p. 41). You can assign individual transition effects to positions 1 through 8 of the video fader. Making this setting lets you use multiple transition effects in combination.

\* The values of 001 through 227 correspond to the transition effect numbers.

USER 1 -- 4	POSITION 1	001 - 227 * Except 204 -- 207	this specifies the effect assigned to position 1 (A-Bus end).
	POSITION 2		This specifies the effect assigned to position 2.
	POSITION 3		This specifies the effect assigned to position 3.
	POSITION 4		This specifies the effect assigned to position 4.
	POSITION 5		This specifies the effect assigned to position 5.
	POSITION 6		This specifies the effect assigned to position 6.
	POSITION 7		This specifies the sound assigned to position 7.
	POSITION 8		This specifies the effect assigned to position 8 (B-Bus end).
	SWITCHING	OFF, BPMx1, BPMx2, BPMx4	This turns on/off the automatic switching feature for synchronization in time with the BPM.

The default assignments to POSITION 1 -- 8 are as follows.

	USER 1	USER 2	USER 3	USER 4
POSITION 1	099 : Wipe94	010 : Wipe05	054 : Wipe49	092 : Wipe87
POSITION 2	096 : Wipe91	011 : Wipe06	060 : Wipe55	081 : Wipe76
POSITION 3	094 : Wipe89	014 : Wipe09	057 : Wipe52	104 : Wipe99
POSITION 4	093 : Wipe88	015 : Wipe10	058 : Wipe53	049 : Wipe44
POSITION 5	094 : Wipe90	017 : Wipe12	054 : Wipe49	029 : Wipe24
POSITION 6	097 : Wipe92	018 : Wipe13	060 : Wipe55	073 : Wipe68
POSITION 7	098 : Wipe93	019 : Wipe14	057 : Wipe52	029 : Wipe24
POSITION 8	099 : Wipe94	021 : Wipe16	058 : Wipe53	092 : Wipe87
SWITCHING	Off	Off	BPMx2	Off

### User-set Transition Effects (User Transition)

Using the user transition feature lets you assign eight transition effects to the video fader. As the following figure shows, transition effects are assigned to eight equally spaced positions along the stroke of the video fader.

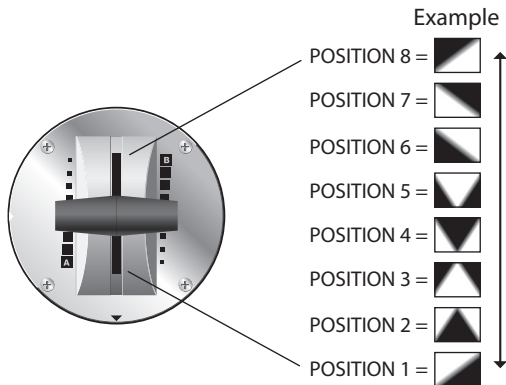

Use the following procedure to make assignments.

- From the TRANSITION menu, select a user-setting number (USER 1 -- USER 4).
- Select the position to assign the transition effect (POSITION 1 -- POSITION 8).

#### MEMO

You can also perform automatic switching at the tempo set using BPM as you apply a transition effect set to POSITION 1 through 8. Go to the TRANSITION menu and select [SWITCHING], then select the setting from among the following. Selecting OFF results in no automatic switching.

- BPMx1 Automatic switching is performed at the tempo set using BPM.
- BPMx2 Automatic switching is performed at double the BPM tempo.
- BPMx4 Automatic switching is performed at four times the BPM tempo.

### PinP Menu

Use the [PinP 1-4] button or [PinP 5-8] button to access the setup menu. Select a value from 1 to 8, then make the settings for the following items.

#### MEMO

PinP 1 -- 8 correspond to effect numbers 140 -- 147. You can access the settings for PinP 1 -- 8 by pressing the [EFFECTS] button.

SAVE CURRENT PinP	This saves the current PinP settings.	
H.POSITION	0 - 705	This specifies the position of the inset screen in the horizontal direction.
V.POSITION	0 - 239	This specifies the position of the inset screen in the vertical direction.
HV.SIZE	1 - 220	This adjusts the size of the inset screen at a fixed aspect ratio.
H.SIZE	1 - 220	This adjusts the horizontal size of the inset screen.
V.SIZE	1 - 220	This adjusts the vertical size of the inset screen.
BORDER	0 - 15	This adjusts the border width for the inset screen.
BORDER COLOR	BLACK, WHITE, GRAY, RED, GREEN, BLUE, YELLOW, CYAN, MAGENTA, ORANGE, GREN-CYAN, BLUE-MGNT, YELW-GREN, BLUE-CYAN, PINK	This specifies the border color for the inset screen.
SHADOW	0 - 15	This specifies the length of the shadow added to the inset screen.
SHADOW COLOR	BLACK, WHITE, GRAY, RED, GREEN, BLUE, YELLOW, CYAN, MAGENTA, ORANGE, GREN-CYAN, BLUE-MGNT, YELW-GREN, BLUE-CYAN, PINK	This specifies the color of the shadow added to the inset screen.
TRIMMING	0 - 30	This specifies the trimming width for the inset screen.

## CH 4 ADJUST Menu

You can set the following items for input on channel 4 only.

### NOTE

However, it's not possible to adjust values below for composite input of CH 4.

H.POSITION	-200 - [0] - 500	This adjusts the display position in the horizontal direction.
V.POSITION	-200 - [0] - 500	This adjusts the display position in the vertical direction.
H.SIZE	[100.0%] - 150.0%	This adjusts the size in the horizontal direction.
V.SIZE	[100.0%] - 150.0%	This adjusts the size in the vertical direction.
CONTRAST	0 - [64] - 127	This adjusts the contrast.
BRIGHTNESS	0 - [64] - 127	This adjusts the brightness.
SHARPNESS	[0] - 127	This adjusts the sharpness of outlines.
FLICK FILTER	0 - [7] - 10	This adjusts the degree of flicker reduction. The flicker filter works to blur or equalize the brightness differences between scanning lines.
COLOR	0 - [64] - 127	This adjusts the color.
INPUT RESOLUTION	[AUTO], 480/576i, 480/576p, 720p, 1080i, 1080p, 640x480, 800x600, 1024x768, 1280x768, 1280x1024, 1366x768, 1400x1050, 1600x1200, 1920x1200	This sets the input resolution. This setting is effective when the input setting for channel 4 is HDMI or RGB/COMPONENT.

\* The valid setting range of H.POSITION and V.POSITION differs depending of the input resolution. In the invalid range, changing of the value does not alter the image position.

## MEMORY Menu

COPY MEMORY	Current No. ->[2] - 8	This copies the data at the current memory number to a different number.
EXCHANGE MEMORY	Current No. <->[2] - 8	This exchanges the data at the current memory number with the data at another number.
MEMORY PROTECT	[OFF], ON	This protects the data at the current memory number.

## MIDI Menu

For information about operating the unit by remote control using MIDI, download "Remote Control Guide" from the following Roland website.

<http://www.rolandsystemsgroup.net/>

## Menu Operations and Menu List

### SETUP Menu

HDCP	[OFF], ON	This turns HDCP on/off.
OUTPUT RESOLUTION	[AUTO], 480/576i, 480/576p, 720p, 1080i, 1080p, 640x480, 800x600, 1024x768, 1280x768, 1280x1024, 1366x768, 1400x1050, 1600x1200., 1920x1200	This specifies the output resolution.
OUTPUT H.POSITION	-200 - [0] - 500	This adjusts the output position in the horizontal direction.
OUTPUT V.POSITION	-200 - [0] - 500	This adjusts the output position in the vertical direction.
OUTPUT H.SIZE	50.0% - [100.0%] - 150.0%	This adjusts the output size in the horizontal direction.
OUTPUT V.SIZE	50.0% - [100.0%] - 150.0%	This adjusts the output size in the vertical direction.
OUTPUT CONTRAST	0 - [64] - 127	This adjusts the output contrast.
OUTPUT BRIGHTNESS	0 - [64] - 127	This adjusts the output brightness.
OUTPUT COLOR	0 - [64] - 127	This adjusts the output color.
OUTPUT COLOR SPACE	[AUTO], RGB-FULL, RGB-LIMIT, YCbCr	This sets the output color space.
OUTPUT DVI-D/HDMI	[AUTO], DVI-D, HDMI	This sets the output mode of the HDMI connector.
OUTFADE WHITE LEVEL	0 - [255]	This sets the white level during output fade.
OUTFADE BLACK LEVEL	[0] - 255	This sets the black level during output fade.
AUTO CHANNEL SCAN	[OFF], ON	This turns on/off the auto switching of CH1 through CH4.
AUTO SCAN TIME	1 - [5] - 120 sec	This sets the interval of auto switching.
AUTO TRANSITION TIME	0.0 - [0.5] - 4.0 sec	This sets the time of transition effect that is applied for auto switching.
AUDIO IN-CH4 FOLLOW	[OFF], ON	When [ON] is selected, the level of AUDIO IN is increased when you switch video channel 4.
NAM/FAM CROSS POINT	0 - [50] - 100	This sets the point during NAM/FAM transition (p. 46).
FADER MODE	[NORMAL], QUICK	This selects the operation mode of the video fader.
FADER CURVE	[CURVE-A], CURVE-B, CURVE-C	This selects the operating curve of the video fader.
FADER CALIBRATE A	This performs calibration of the video fader at the A-Bus end.	
FADER CALIBRATE B	This performs calibration of the video fader at the B-Bus end.	
LCD PREVIEW ASPECT	[16:9], 4:3	This selects the aspect ratio of monitor display.
LCD BRIGHTNESS	LOW, [HIGH]	This sets the brightness of the monitor.
MENU DISPLAY LEVEL	5 - [13] - 15	This adjusts the appearance level of menu display.
BCKGND LEV - OVERLAY	1 - [12]	This adjusts the brightness of the background (four-way split screen) in overlay display.
NO SIGNAL BACK	[BLACK], BLUE	This selects the background color at times of no input.
COLOR BAR OUTPUT	[OFF], ON	This selects whether a color bar is output.
AUTO OFF	OFF, [ON]	This makes the setting for AUTO OFF. When [ON] is selected, power is turned off automatically (p. 10).
USB STREAMING	[OUTPUT], MONITOR	This selects the output from the USB port.
NTSC/PAL	NTSC, PAL	This switches between NTSC and PAL.
FACTORY RESET	This returns the unit to its factory defaults.	

\* The valid setting range of OUTPUT H.POSITION and OUTPUT V.POSITION differs depending of the output resolution. In the invalid range, changing of the value does not alter the image position.

# Appendices

## Main Specifications

### Signal Processing

Video	4:2:2 (Y/Pb/Pr), 8 bits (Internal Processing : 480/59.94p when set to NTSC, 576/50p when set to PAL)
Audio	Sampling Rate : 24 bits/48 kHz, 2 ch

### Input/Output Formats

Refer to "About Input/Output Formats" (p. 23).

### Input/Output Connectors

Input	Video	HDMI	Type A (19 pins) x 4 (INPUT 1 -- 4)
		RGB/Component	HD DB-15 type x 1 (INPUT 4)
		Composite	BNC Type x 4 (INPUT 1 -- 4)
		S-Video	4-pin mini DIN type x 1 (INPUT 4)
	Audio	RCA pin type x 1 pair (AUDIO IN)	
Output	Final Output	HDMI	Type A (19 pins) x 1 (OUTPUT)
		RGB/Component	HD DB-15 type x 1 (OUTPUT)
		Composite	BNC type x 1 (OUTPUT)
	Preview Output	HDMI	Type A (19 pins) x 1 (PVW OUT)

### Other Connectors

MIDI	5 pins DIN type x 2 (IN, OUT/THRU)
USB	B type x 1 (for streaming and remote control)

### Signal Level/Impedance

RGB/Component	Signal Level	1.0 Vp-p (luminance), 0.7 Vp-p (chroma)
	Impedance	75 ohms
Composite	Signal Level	1.0 Vp-p
	Impedance	75 ohms
S-Video	Signal Level	1.0 Vp-p
	Impedance	75 ohms
Analog Audio	Nominal Input Level	- 10 dBu
	Maximum Input Level	+ 8 dBu
	Impedance	15 k ohms

### Video Effects

Transition	Mix, Cut, Wipe (259 patterns)
Composition/Filter	Picture in Picture, Luminance Key, Chroma Key, Strobe, Negative, Colorize, Feedback, Emboss, Multi, Mirror etc. (148 types)
Others	Output Fade, Freeze

### Others

Display	Graphic Color LCD, 320 x 240 dots, touch panel
Power Supply	AC adaptor (DC 9V)
Current Draw	2.0 A
Dimensions	225 (W) x 296 (D) x 105 (H) mm 8-7/8 (W) x 11-11/16 (D) x 4-3/16 (H) inches
Weight (excl. AC adaptor)	2.6 kg 5 lbs 12 oz
Accessories	AC adaptor, Power Cord, RCA - BNC conversion plug x 2, Owner's Manual

\* 0 dBu = 0.775 Vrms

\* In the interest of product improvement, the specifications and/or appearance of this unit are subject to change without prior notice.

## Effects List

You can assign transition effects to the MIX, WIPE, and EFX buttons. You can also allocate filter effects and compositing effects to the A-A-Bus and B-Bus Effect buttons.

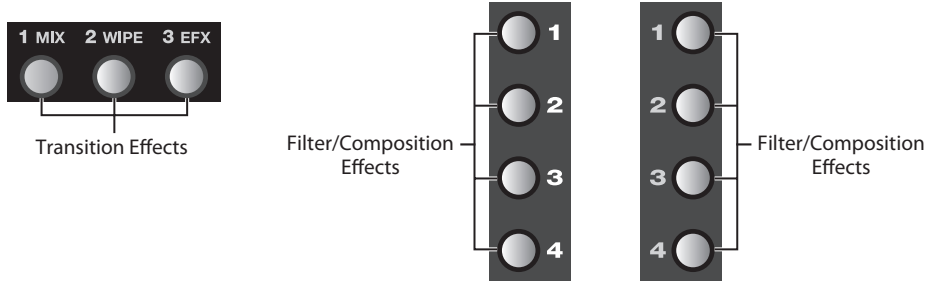

**MEMO**

If an effect has an "\*" (asterisk) after its name, you can change its setting value in a smooth, continuous manner by turning the Effect Control dial. Pressing a button to which such an effect is assigned makes the button flash. If no effect indicated by an "\*" is assigned to the button, the button lights up steadily when pressed. In such cases, operation of the Effect Control dial has no effect.

**MEMO**

When multiple controllable effects are assigned to these buttons, you can control the effect of last pressed button using the dial. In such case, the last pressed button flashes and previously pressed button(s) lights up steadily.

### Transition Effects

**Mix**



001 : Mix01	The A and B video is switched gradually.
002 : Fam01	This is an abbreviation of "full additive mix." The A and B luminance levels are maintained during the transition.
003 : Fam*	You can move the A/B cross point during FAM transition.
004 : Nam01	This is an abbreviation of "non-additive mix." Display during transition starts with areas of high luminance.
005 : Nam*	You can move the A/B cross point during NAM transition.

**MEMO**

You can set the cross point (0% to 100%) by going to the SETUP menu (p. 44) and setting [NAM/FAM CROSS POINT].

Wipe



In the following wipe illustrations, black areas represent the picture after the transition (the picture that appears), and white areas represent the picture before the transition (the picture that disappears).

006 : Wipe01



007 : Wipe02

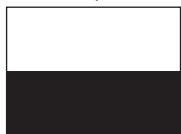

008 : Wipe03



009 : Wipe04



010 : Wipe05



011 : Wipe06



012 : Wipe07



013 : Wipe08



014 : Wipe09



015 : Wipe10



016 : Wipe11



017 : Wipe12



018 : Wipe13



019 : Wipe14

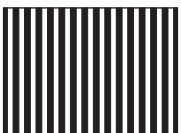

020 : Wipe15

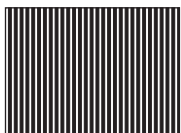

021 : Wipe16

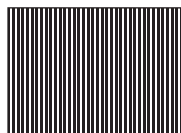

022 : Wipe17



023 : Wipe18



024 : Wipe19



025 : Wipe20



026 : Wipe21

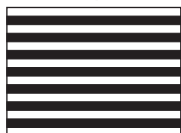

027 : Wipe22



028 : Wipe23

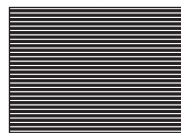

029 : Wipe24

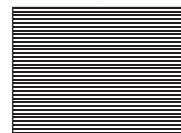

030 : Wipe25



031 : Wipe26



032 : Wipe27



033 : Wipe28



034 : Wipe29



035 : Wipe30



036 : Wipe31



037 : Wipe32



038 : Wipe33



039 : Wipe34



040 : Wipe35



041 : Wipe36



042 : Wipe37



043 : Wipe38



044 : Wipe39

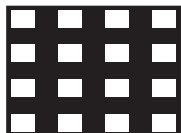

045 : Wipe40

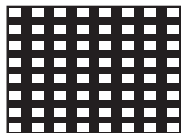

046 : Wipe41

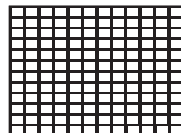

047 : Wipe42

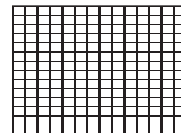

048 : Wipe43

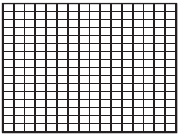

049 : Wipe44

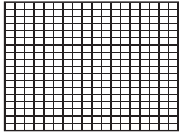

050 : Wipe45



051 : Wipe46



052 : Wipe47



053 : Wipe48



054 : Wipe49



055 : Wipe50

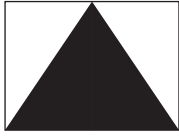

056 : Wipe51

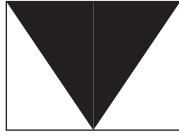

057 : Wipe52



058 : Wipe53



059 : Wipe54

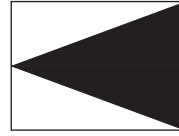

060 : Wipe55



061 : Wipe56

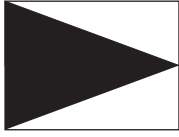

062 : Wipe57

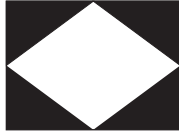

063 : Wipe58



064 : Wipe59



065 : Wipe60

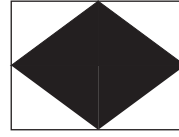

066 : Wipe61



067 : Wipe62



068 : Wipe63



069 : Wipe64

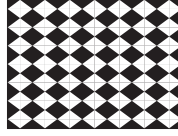

070 : Wipe65

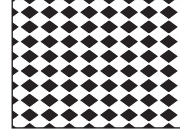

071 : Wipe66

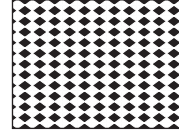

072 : Wipe67

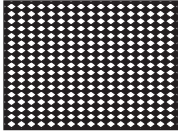

073 : Wipe68

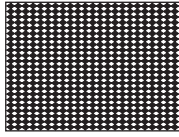

074 : Wipe69



075 : Wipe70



076 : Wipe71



077 : Wipe72



078 : Wipe73

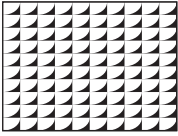

079 : Wipe74

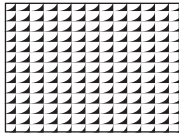

080 : Wipe75

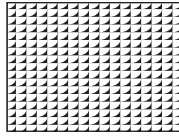

081 : Wipe76

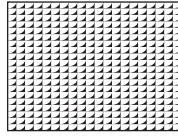

082 : Wipe77



083 : Wipe78



084 : Wipe79



085 : Wipe80



086 : Wipe81

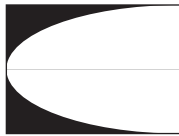

087 : Wipe82

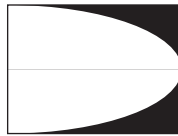

088 : Wipe83



089 : Wipe84



090 : Wipe85

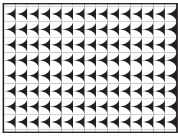

091 : Wipe86

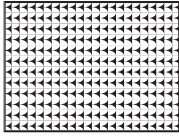

092 : Wipe87

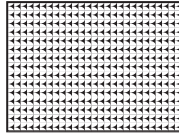

093 : Wipe88

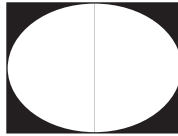

094 : Wipe89

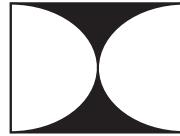

095 : Wipe90



096 : Wipe91



097 : Wipe92



098 : Wipe93

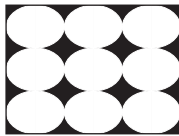

099 : Wipe94

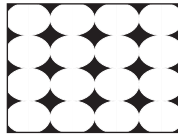

100 : Wipe95

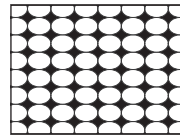

101 : Wipe96

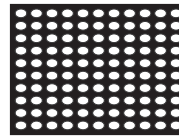

102 : Wipe97

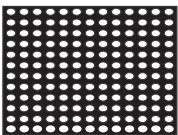

103 : Wipe98

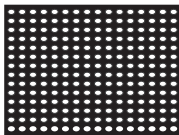

104 : Wipe99

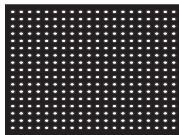



105 : SWipe01



106 : SWipe02



107 : SWipe03



108 : SWipe04



109 : SWipe05



110 : SWipe06

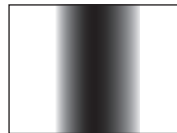

111 : SWipe07



112 : SWipe08



113 : SWipe09

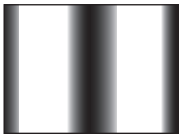

114 : SWipe10



115 : SWipe11



116 : SWipe12



117 : SWipe13

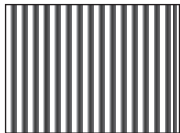

118 : SWipe14

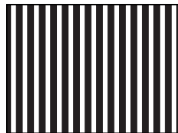

119 : SWipe15

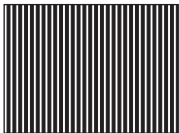

120 : SWipe16

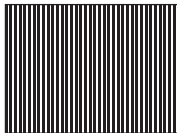

121 : SWipe17



122 : SWipe18

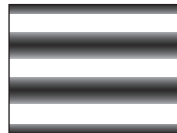

123 : SWipe19

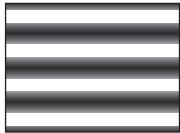

124 : SWipe20

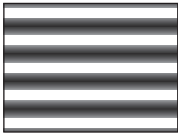

125 : SWipe21

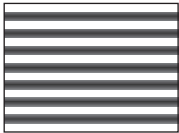

126 : SWipe22



127 : SWipe23

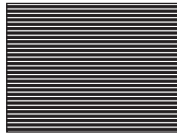

128 : SWipe24

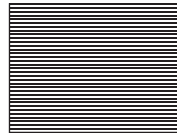

129 : SWipe25



130 : SWipe26



131 : SWipe27



132 : SWipe28



133 : SWipe29



134 : SWipe30



135 : SWipe31



136 : SWipe32



137 : SWipe33



138 : SWipe34



139 : SWipe35



140 : SWipe36



141 : SWipe37



142 : SWipe38



143 : SWipe39

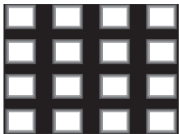

144 : SWipe40



145 : SWipe41

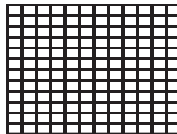

146 : SWipe42

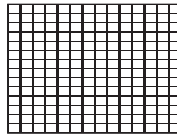

147 : SWipe43

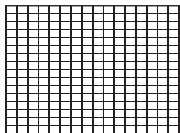

148 : SWipe44

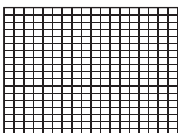

149 : SWipe45



150 : SWipe46



151 : SWipe47

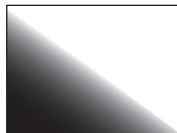

152 : SWipe48



153 : SWipe49



154 : SWipe50

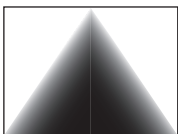

155 : SWipe51

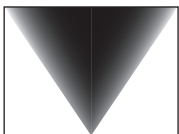

156 : SWipe52



157 : SWipe53

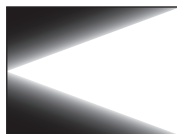

158 : SWipe54

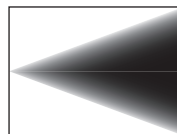

159 : SWipe55



160 : SWipe56

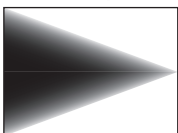

161 : SWipe57



162 : SWipe58



163 : SWipe59

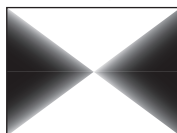

164 : SWipe60

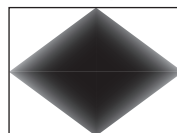

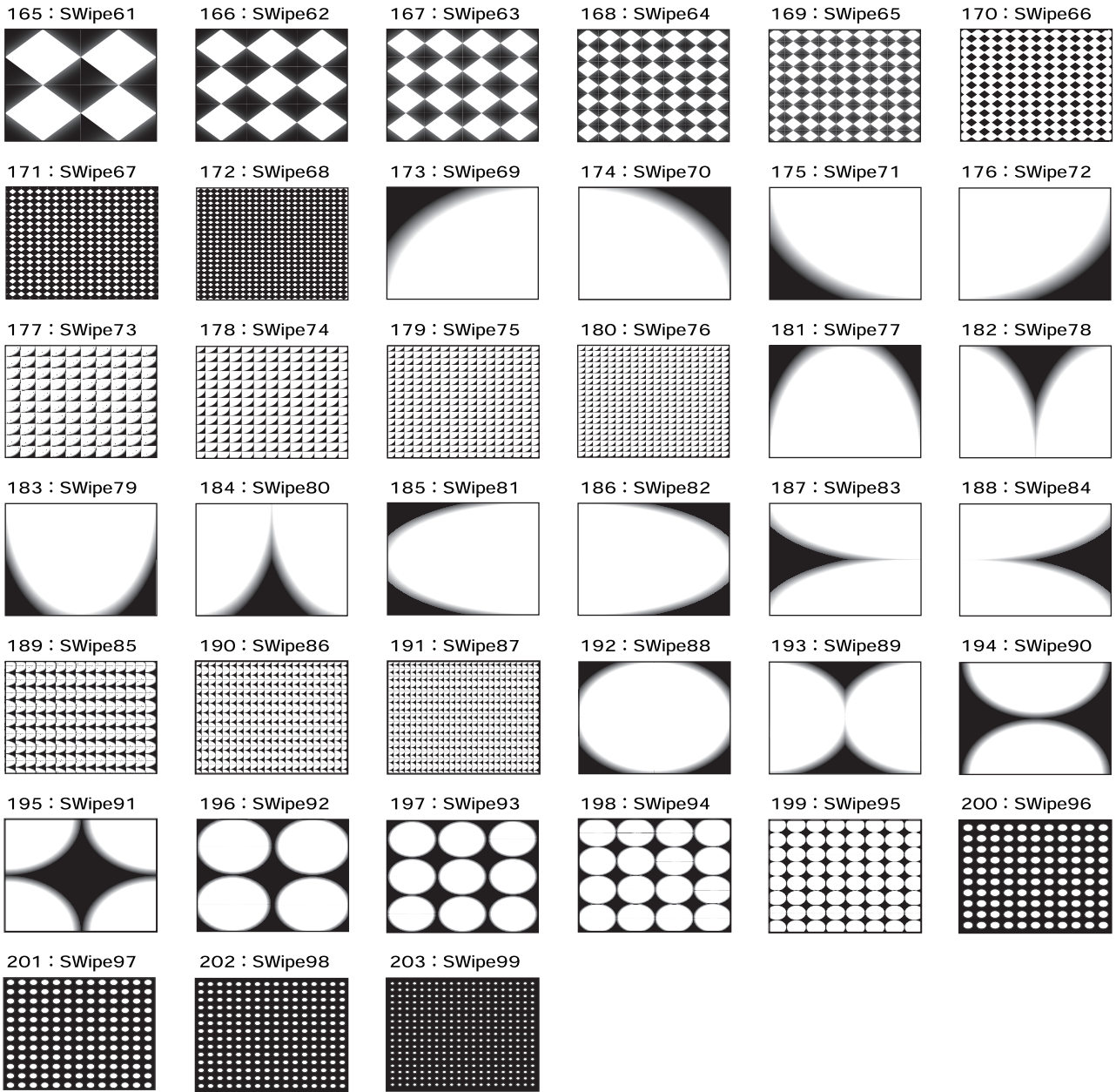

**Key**

The transition starts at light areas or dark areas.

204	Key01	The dark part of the A-Bus picture transitions to the light part of the B-Bus picture.
205	Key02	The light part of the A-Bus picture transitions to the dark part of the B-Bus picture.
206	Key03	The light part of the B-Bus picture transitions to the dark part of the A-Bus picture.
207	Key04	The dark part of the B-Bus picture transitions to the light part of the A-Bus picture.



**Slide (Normal)**

208 : Slide01



209 : Slide02



210 : Slide03



211 : Slide04



212 : Slide05



213 : Slide06



214 : Slide07



215 : Slide08



216 : Slide09



217 : Slide10



218 : Slide11



219 : Slide12



220 : Slide13



221 : Slide14



222 : Slide15



223 : Slide16



224 : Slide17



225 : Slide18



226 : Slide19



227 : Slide20



**Slide (Sequential)**

228 : Slide21



1. A → B



2. B → A

228 : Slide22



1. A → B



2. B → A

230 : Slide23



1. A → B

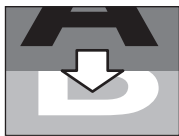

2. B → A

231 : Slide24



1. A → B



2. B → A

232 : Slide25



1. A → B



2. B → A



3. A → B



4. B → A

233 : Slide26



1. A → B



2. B → A



3. A → B

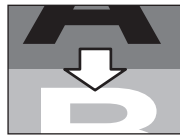

4. B → A

Stretch

234 : Stretch01



235 : Stretch02



236 : Stretch03



237 : Stretch04



238 : Stretch05



239 : Stretch06



240 : Stretch07



241 : Stretch08



242 : Stretch09



243 : Stretch10



244 : Stretch11



245 : Stretch12



246 : Stretch13



247 : Stretch14



248 : Stretch15



249 : Stretch16



250 : Stretch17



251 : Stretch18



252 : Stretch19



253 : Stretch20



254 : Stretch21



255 : Stretch22

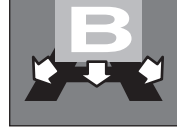

256 : Stretch23



257 : Stretch24

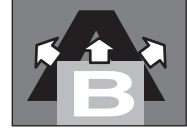

258 : Stretch25



259 : Stretch26



## Filter/Compositing Effects

No.	Effect name	Description
001	STILL	Still (Field Freeze)
002	STROBE1	Strobe
:	:	
010	STROBE9	
011	STROBE*	
012	AFTERIMAGE1	Afterimage (image-trailer effect)
:	:	
015	AFTERIMAGE4	
016	AFTERIMAGE*	
017	FEEDBACK1	Feedback (repeated layering of the picture upon itself)
:	:	
020	FEEDBACK4	
021	FEEDBACK*	
022	SHAKE1*	Shake
:	:	
027	SHAKE6*	
028	NEGATIVE1	Negative (inversion of brightness/color)
:	:	
030	NEGATIVE3	
031	NEGATIVE*	
032	COLORIZE1	Colorize (addition of color to the picture)
:	:	
039	COLORIZE8	
040	COLORIZE*	
041	FINDEGE1	Find edge (extraction of outlines)
:	:	
048	FINDEGE8	
049	FINDEGE*	
050	SILHOUETTE1	Silhouette (dividing the picture into light and dark areas, blackening dark areas, and applying different color to light areas)
:	:	
057	SILHOUETTE8	
058	SILHOUETTE*	
059	MONOCOLOR1	Monocolor (single-color filter)
:	:	
066	MONOCOLOR8	
067	MONOCOLOR*	
068	EMBOSS1	Emboss (concave/convex image)
:	:	
075	EMBOSS8	
076	EMBOSS*	
082	COLORPASS1	Color pass (making monochrome while leaving a specific color)
:	:	
089	COLORPASS8	
090	COLORPASS*	
091	W-LUMIKEY	Luminance key (white extraction)
092	W-LUMIKEY*	
093	B-LUMIKEY	Luminance key (black extraction)
094	B-LUMIKEY*	

No.	Effect name	Description
095	CHROMAKEY	Chroma key
096	CHROMAKEY*	
097	FLIP-H	Flip (left/right flip)
098	FLIP-V	Flip (top/bottom flip)
099	FLIP-HV	Flip top/bottom and left/right flip)
100	FLIP*	Flip (variable)
101	MULTI-H1	Multi-screen (divided horizontally)
:	:	
107	MULTI-H7	
108	MULTI-H*	
109	MULTI-V1	Multi-screen (divided vertically)
:	:	
115	MULTI-V7	
116	MULTI-V*	
117	MULTI-HV1	Multi-screen (divided horizontally and vertically)
:	:	
123	MULTI-HV7	
124	MULTI-HV*	
125	MIRROR-H1	Mirror (divided horizontally)
:	:	
128	MIRROR-H4	
129	MIRROR-H*	
130	MIRROR-V1	Mirror (divided vertically)
:	:	
133	MIRROR-V4	
134	MIRROR-V*	
135	MIRROR-HV1	Mirror (divided horizontally and vertically)
:	:	
138	MIRROR-HV4	
139	MIRROR-HV*	
140	PinP1	Picture-in-Picture
:	:	
147	PinP8	
148	PinP*	

**Effects that Can Be Controlled by the [CONTROL] Dial**

If you have assigned an effect that has an “\*” (asterisk) following its effect name, you can use the [CONTROL] dial to modify the following settings. The EFFECTS button whose settings can be modified will flash.

No.	Effect name	Setting controlled by the [CONTROL] dial
011	STROBE*	Change the spacing at which the still images will be output (nine levels).
016	AFTERIMAGE*	Change the time that the afterimage is shown (four levels).
021	FEEDBACK*	Change the strength of the effect over four levels.
022	SHAKE1*	Adjusts the speed at which the image will shake.
:		
026	SHAKE6*	
031	NEGATIVE*	Change the portion that is inverted (Invert brightness and color > Invert color > Invert brightness >).
040	COLORIZE]	Change the colorization pattern (eight types).
049	FINEDGE]	Smoothly changes the color of the outline edge and background.
058	SILHOUETTE]	Smoothly changes the color applied to the image.
067	MONOCOLOR]	Smoothly changes the color of the color filter.
076	EMBOSS]	Smoothly changes the color applied to the image.
081	POSTERIZE]	Change the strength of the effect (four levels).
090	COLORPASS]	Change the color that remains (eight types).
092	W-LUMIKEY]	Change the white luminance key level.
094	B-LUMIKEY]	Change the black luminance key level.
096	CHROMAKEY]	Change the chromakey level.
100	FLIP]	Change the direction in which the image is flipped (Flip left/right/top/bottom > Flip top/bottom > Flip left/right >).
108	MULTI-H]	Change the pattern by which the image is divided vertically (seven types).
116	MULTI-V]	Change the pattern by which the image is divided horizontally (seven types).
124	MULTI-HV]	Change the pattern by which the image is divided horizontally and vertically (seven types).
129	MIRROR-H]	Change the pattern by which the image is divided vertically (four types).
134	MIRROR-V]	Change the pattern by which the image is divided horizontally (four types).
139	MIRROR-HV]	Change the pattern by which the image is divided horizontally and vertically (four types).
148	PinP]	Changes the position (eight types) of the subscreen. * The position of the subscreen will reflect the [140: PinP1] -- [147: PinP8] settings.

## Effects That Cannot Be Used Simultaneously

### NOTE

The following effect combinations cannot be used simultaneously. When such effect is selected, the effect name is shown as [-----] in the setup screen (p. 26).

#### Combinations Composed of a Transition Effect and a Filter/Compositing Effect

Transition effect	Filter/compositing effects that cannot be used simultaneously
Key	SILHOUETTE, W-LUMIKEY, B-LUMIKEY, CHROMAKEY
Slide	SILHOUETTE, SHAKE, W-LUMIKEY, B-LUMIKEY, CHROMAKEY, FLIP, MULTI, MIRROR, PinP
Stretch	SILHOUETTE, SHAKE, W-LUMIKEY, B-LUMIKEY, CHROMAKEY, FLIP, MULTI, MIRROR, PinP

#### Combinations Composed of a Composition Effect and a Transition Effect

Composition effect	Transition effects that cannot be used simultaneously
PinP	Fam, Nam, Wipe, SWipe, Key, Slide, Stretch, User

\* When PinP is turned on, the assigned effects to [TRANSITION] buttons are all changed to MIX for a while.

#### Combinations Composed of Two Filter/Compositing Effects

First effect	Filter/compositing effects that cannot be used simultaneously
STILL	STILL, STROBE, AFTERIMAGE, FEEDBACK, FINDEDGE, EMBOSS, MULTI, PinP
STROBE	STILL, STROBE, FINDEDGE, EMBOSS, MULTI, PinP
AFTERIMAGE	AFTERIMAGE, FEEDBACK(*1), SILHOUETTE, W-LUMIKEY, B-LUMIKEY, CHROMAKEY, PinP
FEEDBACK	AFTERIMAGE(*2), FEEDBACK, SILHOUETTE, W-LUMIKEY, B-LUMIKEY, CHROMAKEY, PinP
SHAKE	SHAKE, FLIP, MULTI, MIRROR, PinP
NEGATIVE	NEGATIVE, COLORIZE, FINDEDGE, SILHOUETTE, MONOCOLOR, EMBOSS, POSTERIZE, COLORPASS
COLORIZE	NEGATIVE, COLORIZE, FINDEDGE, SILHOUETTE, MONOCOLOR, EMBOSS, POSTERIZE, COLORPASS
FINDEDGE	NEGATIVE, COLORIZE, FINDEDGE, SILHOUETTE, MONOCOLOR, EMBOSS, POSTERIZE, COLORPASS
SILHOUETTE	AFTERIMAGE, FEEDBACK, NEGATIVE, COLORIZE, FINDEDGE, SILHOUETTE, MONOCOLOR, EMBOSS, POSTERIZE, COLORPASS, W-LUMIKEY, B-LUMIKEY, CHROMAKEY, PinP
MONOCOLOR	NEGATIVE, COLORIZE, FINDEDGE, SILHOUETTE, MONOCOLOR, EMBOSS, POSTERIZE, COLORPASS
EMBOSS	NEGATIVE, COLORIZE, FINDEDGE, SILHOUETTE, MONOCOLOR, EMBOSS, POSTERIZE, COLORPASS
POSTERIZE	NEGATIVE, COLORIZE, FINDEDGE, SILHOUETTE, MONOCOLOR, EMBOSS, POSTERIZE, COLORPASS
COLORPASS	NEGATIVE, COLORIZE, FINDEDGE, SILHOUETTE, MONOCOLOR, EMBOSS, POSTERIZE, COLORPASS
W-LUMIKEY	AFTERIMAGE, FEEDBACK, SILHOUETTE, W-LUMIKEY, B-LUMIKEY, CHROMAKEY
B-LUMIKEY	AFTERIMAGE, FEEDBACK, SILHOUETTE, W-LUMIKEY, B-LUMIKEY, CHROMAKEY
CHROMAKEY	AFTERIMAGE, FEEDBACK, SILHOUETTE, W-LUMIKEY, B-LUMIKEY, CHROMAKEY
FLIP	STILL(*3), STROBE (*3), SHAKE, FLIP, MULTI, MIRROR, PinP
MULTI	STILL(*4), STROBE (*4), SHAKE, FLIP, MULTI, MIRROR, PinP
MIRROR	STILL(*5), STROBE (*5), SHAKE, FLIP, MULTI, MIRROR, PinP
PinP	STILL(*6), STROBE(*6), AFTERIMAGE, FEEDBACK, SHAKE, SILHOUETTE, FLIP, MULTI, MIRROR, PinP,

\*1 "FEEDBACK" takes priority for both A-Bus and B-Bus.

\*2 "AFTERIMAGE" takes priority for both A-Bus and B-Bus.

\*3 When "FLIP\*" is on, operating [CONTROL] turns off "STILL" or "STROBE."

\*4 When "MULTI-H\*," "MULTI-V\*," or "MULTI-HV\*" is on, operating [CONTROL] turns off "STILL" or "STROBE."

\*5 When "MIRROR-H\*," "MIRROR-V\*," or "MIRROR-HV\*" is on, operating [CONTROL] turns off "STILL" or "STROBE."

\*6 When "PinP\*" is on, operating [CONTROL] turns off "STILL" or "STROBE."

## Calibrating and Changing the Installed Orientation of the Video Fader

### Calibrating the Video Fader

After repeated use of the V-4EX, you may find that 100% of the image is not output even when you've moved the video fader all the way toward A-Bus or B-Bus. If this occurs, perform calibration of the video fader.

**1. Move to the A-Bus end.**

Move the video fader all the way toward the A-Bus position.

**2. Access the SETUP menu.**

Press the [MENU] button to access the menu screen, then use the touch panel to select [SETUP].

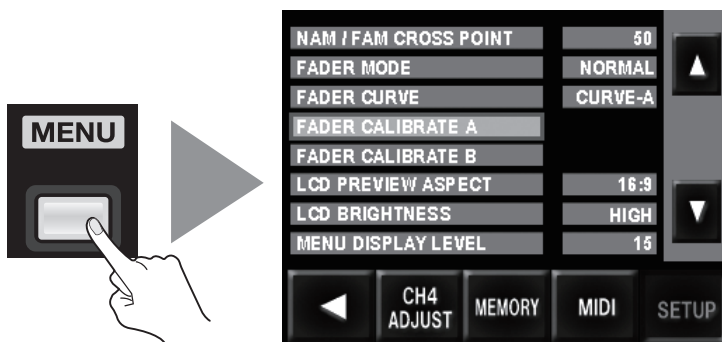

**3. Calibrate the A-Bus position.**

Select [FADER CALIBRATE A] and press the [VALUE] dial. The display changes to a confirmation screen. Press the [VALUE] dial once more.



**4. Move to the B-Bus end.**

Move the video fader all the way to the B-Bus position.

**5. Calibrate the B-Bus position.**

Select [FADER CALIBRATE B] and press the [VALUE] dial. The display changes to a confirmation screen. Press the [VALUE] dial once more.

**6. Go back to the original screen.**

Press the [MENU] button several times to quit the menu screen and go back to the original screen.



## Changing the Installed Orientation of the Video Fader

You can change the orientation in which the video fader is installed by 90 degrees.

### NOTE

Before you remove the video fader, turn off the power to the unit and unplug the AC adapter from the power outlet.

#### 1. Turn off the power.

Before you attempt to change the orientation of the video fader, be sure to turn off the power to the V-4EX.

#### 2. Remove the screws.

Remove the four screws shown below.

After you remove the screws, keep from touching the internal circuitry or connectors with your hands.

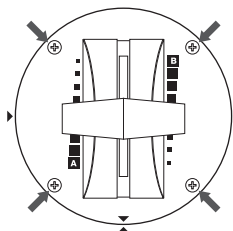

#### 3. Change the orientation of the video fader.

Rotate the video fader 90 degrees. When doing this, align the triangular symbol printed on the video fader panel (circular) with the triangular symbol printed on the V-4EX's top panel.

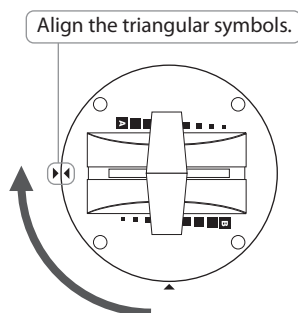

### NOTE

When changing the orientation of the video fader, never pull the video fader upward or rotate it more than 90 degrees. Doing so may disconnect or break the cable that connects the video fader to the V-4EX.

#### 4. Secure the video fader in place.

Using the screws you removed in step 2, fasten the video fader panel to the top panel of the V-4EX. After securing it in place, check again to make sure it is installed correctly.

### NOTE

When fastening, never use and screws other than the ones you removed in step 2.

## About Remote Control

### MIDI and USB

The V-4EX supports remote control by MIDI or USB, and can be operated remotely from an external device. When performing remote control, download "Remote Control Guide" from the following Roland website.

<http://www.rolandsystemsgroup.net/>

### MIDI VISUAL CONTROL

The V-4EX can be operated remotely from a device that supports MIDI Visual Control. MIDI Visual Control is a feature that uses MIDI to link visual expression to a musical performance.



## Security Slot

You can attach a commercially available security wire here to prevent theft.

<http://www.kensington.com/>

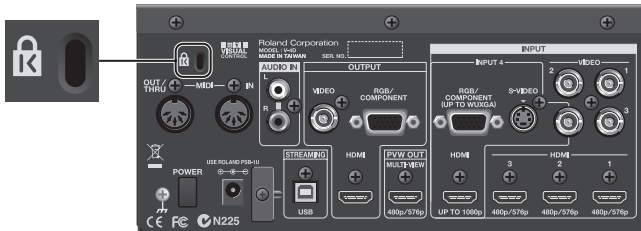

## Dimensions

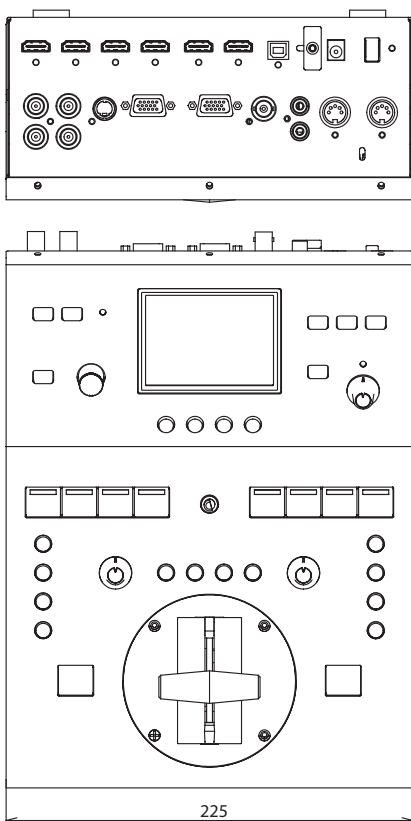

Unit : mm

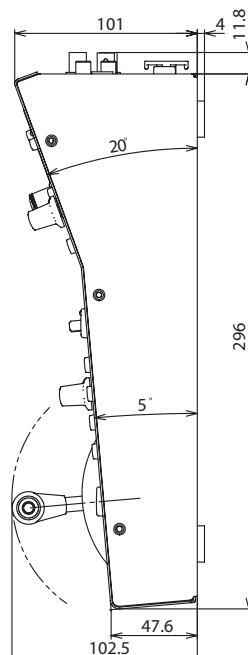

## Troubleshooting

### **The volume level of equipment connected to the AUDIO IN jacks is too low.**

Are you using connection cables that contain resistors? Use connector cables that do not contain resistors.

### **No input picture is displayed.**

Is a device that does not support 480p or 576p output connected to INPUT 1, 2, or 3? Connect such unsupported equipment to INPUT 4.

### **No signal is output from the RGB/COMPONENT connector or the composite jack.**

Is HDCP turned on? Turning on HDCP stops RGB/component, composite and USB output. Note, however, that HDCP-applied signals continue to be output from the HDMI connectors. Refer to "Inputting HDCP Signals" (p. 24).

### **The color of the picture output from the RGB/COMPONENT connector is strange.**

Has the precise output format been selected? When an interlaced output format is selected, component signals are output from the RGB/COMPONENT connector. When a noninterlaced format is selected, RGB signals are output from the RGB/COMPONENT connector.

### **A-Bus or B-Bus does not transition completely.**

If output of a slight amount of the picture on the opposite bus continues even when the control has been moved all the way, carry out the procedure in "Calibrating the Video Fader" (p. 56).

### **Nothing is displayed on the preview monitor.**

Does the connected monitor support 480/59.94p (when set to NTSC) or 576/50p (when set to PAL)? Connect equipment that supports these output formats.

### **Nothing is displayed on the built-in monitor.**

Is any of the MONITOR buttons illuminated? Nothing is displayed when all are dark.

### **Video cannot be switched using the touch panel.**

Has the video fader been moved all the way to one end of its stroke? The touch panel cannot be used to perform a transition when the video fader has not been moved all the way. The touch panel also cannot be used to perform a transition while a menu is displayed.

### **Fade cannot be applied to output.**

Has operation of the [OUTPUT FADE] dial been disabled? When [OUT-FADE] has been set to [No Ctrl] at the setup screens, the dial cannot be used to apply fade.

### **Panel settings cannot be saved.**

Is [1] selected by the MEMORY dial? Settings cannot be saved when the dial is at [1]. Select a different number before changing settings.

Are settings protected? Even when a number other than [1] is selected, settings cannot be saved if they are protected. Go to the MEMORY menu and set [PROTECT] to [OFF].

### **The stroke ends of the video fader are unresponsive.**

Is the operating curve set to [Curve B] or [Curve C]? When the setting is Curve B, the end areas are less sensitive. When the setting is Curve C, the end areas are completely unresponsive. Going to the SETUP menu and selecting [Curve A] for [FADER CURVE] makes it possible to use the full length of the stroke.

### **Two effects cannot be used simultaneously.**

With some combinations of effects, using two effects simultaneously is not possible. Refer to "Effects That Cannot Be Used Simultaneously" (p. 54).

# Index

<b>A</b>	
Audio Balance .....	36
Audio Source .....	18
AUTO OFF .....	10
<b>B</b>	
BPM .....	29
<b>C</b>	
Calibrate .....	56
Chroma Key .....	33
Component .....	17
Composite .....	16
Computer .....	20
Cord Hook .....	9
<b>D</b>	
delay .....	37
<b>E</b>	
Effects List .....	46
Enabled Connector .....	17
<b>F</b>	
Fade .....	31
Filter .....	32
Formats .....	23
freeze .....	31
<b>H</b>	
HDCP .....	24
HDMI .....	16
<b>L</b>	
Lip-sync .....	37
Luminance Key .....	34
<b>M</b>	
MEMORY .....	38
Menu .....	40
MIDI .....	58
MIDI VISUAL CONTROL .....	58
Monitor .....	11
<b>O</b>	
Operating System .....	20
Orientation .....	57
<b>P</b>	
Picture-in-Picture .....	35
Preview Monitor .....	19
Projector .....	19
<b>R</b>	
Remote Control .....	58
RGB .....	17
<b>S</b>	
Signal Flow .....	15
Source .....	16
Streaming .....	20
S-Video .....	16
Switching .....	27
<b>T</b>	
Touch Panel .....	28
transition effect .....	27
Transition Section .....	13
<b>U</b>	
User Transition .....	42
<b>V</b>	
Video Fader .....	27
View Mode .....	25
Volume .....	36



For EU Countries

This product complies with the requirements of EMC Directive 2004/108/EC.

For the USA

## FEDERAL COMMUNICATIONS COMMISSION RADIO FREQUENCY INTERFERENCE STATEMENT

This equipment has been tested and found to comply with the limits for a Class B digital device, pursuant to Part 15 of the FCC Rules. These limits are designed to provide reasonable protection against harmful interference in a residential installation. This equipment generates, uses, and can radiate radio frequency energy and, if not installed and used in accordance with the instructions, may cause harmful interference to radio communications. However, there is no guarantee that interference will not occur in a particular installation. If this equipment does cause harmful interference to radio or television reception, which can be determined by turning the equipment off and on, the user is encouraged to try to correct the interference by one or more of the following measures:

- Reorient or relocate the receiving antenna.
- Increase the separation between the equipment and receiver.
- Connect the equipment into an outlet on a circuit different from that to which the receiver is connected.
- Consult the dealer or an experienced radio/TV technician for help.

This device complies with Part 15 of the FCC Rules. Operation is subject to the following two conditions:

- (1) this device may not cause harmful interference, and
- (2) this device must accept any interference received, including interference that may cause undesired operation.

This equipment requires shielded interface cables in order to meet FCC class B limit.

Any unauthorized changes or modifications not expressly approved by the party responsible for compliance could void the user's authority to operate the equipment.

For Canada

### NOTICE

This Class B digital apparatus meets all requirements of the Canadian Interference-Causing Equipment Regulations.

### AVIS

Cet appareil numérique de la classe B respecte toutes les exigences du Règlement sur le matériel brouilleur du Canada.

For C.A. US (Proposition 65)

### WARNING

This product contains chemicals known to cause cancer, birth defects and other reproductive harm, including lead.

For the USA

## DECLARATION OF CONFORMITY Compliance Information Statement

**Model Name :** V-4EX  
**Type of Equipment :** Video Mixer  
**Responsible Party :** Roland Systems Group U.S.  
**Address :** 5100 S.Eastern Avenue, Los Angeles, CA 90040-2938, U.S.A.  
**Telephone :** (323) 890 3700

## For EU Countries



- UK** This symbol indicates that in EU countries, this product must be collected separately from household waste, as defined in each region. Products bearing this symbol must not be discarded together with household waste.
- DE** Dieses Symbol bedeutet, dass dieses Produkt in EU-Ländern getrennt vom Hausmüll gesammelt werden muss gemäß den regionalen Bestimmungen. Mit diesem Symbol gekennzeichnete Produkte dürfen nicht zusammen mit den Hausmüll entsorgt werden.
- FR** Ce symbole indique que dans les pays de l'Union européenne, ce produit doit être collecté séparément des ordures ménagères selon les directives en vigueur dans chacun de ces pays. Les produits portant ce symbole ne doivent pas être mis au rebut avec les ordures ménagères.
- IT** Questo simbolo indica che nei paesi della Comunità europea questo prodotto deve essere smaltito separatamente dai normali rifiuti domestici, secondo la legislazione in vigore in ciascun paese. I prodotti che riportano questo simbolo non devono essere smaltiti insieme ai rifiuti domestici.  
Ai sensi dell'art. 13 del D.Lgs. 25 luglio 2005 n. 151.
- ES** Este símbolo indica que en los países de la Unión Europea este producto debe recogerse aparte de los residuos domésticos, tal como esté regulado en cada zona. Los productos con este símbolo no se deben depositar con los residuos domésticos.
- PT** Este símbolo indica que nos países da UE, a recolha deste produto deverá ser feita separadamente do lixo doméstico, de acordo com os regulamentos de cada região. Os produtos que apresentem este símbolo não deverão ser eliminados juntamente com o lixo doméstico.
- NL** Dit symbool geeft aan dat in landen van de EU dit product gescheiden van huishoudelijk afval moet worden aangeboden, zoals bepaald per gemeente of regio. Producten die van dit symbool zijn voorzien, mogen niet samen met huishoudelijk afval worden verwijderd.
- DK** Dette symbol angiver, at i EU-lande skal dette produkt opsamles adskilt fra husholdningsaffald, som defineret i hver enkelt region. Produkter med dette symbol må ikke smides ud sammen med husholdningsaffald.
- NO** Dette symbolet indikerer at produktet må behandles som spesialavfall i EU-land, iht. til retningslinjer for den enkelte regionen, og ikke kastes sammen med vanlig husholdningsavfall. Produkter som er merket med dette symbolet, må ikke kastes sammen med vanlig husholdningsavfall.
- SE** Symbolen anger att i EU-länder måste den här produkten kasseras separat från hushållsavfall, i enlighet med varje regions bestämmelser. Produkter med den här symbolen får inte kasseras tillsammans med hushållsavfall.
- FI** Tämä merkintä ilmaisee, että tuote on EU-maissa kerättävä erillään kotitalousjätteistä kunkin alueen voimassa olevien määräysten mukaisesti. Tällä merkinnällä varustettuja tuotteita ei saa hävittää kotitalousjätteiden mukana.
- HU** Ez a szimbólum azt jelenti, hogy az Európai Unióban ezt a terméket a háztartási hulladéktól elkülönítve, az adott régióban érvényes szabályozás szerint kell gyűjteni. Az ezzel a szimbóllummal ellátott termékeket nem szabad a háztartási hulladék közé dobni.
- PL** Symbol oznacza, że zgodnie z regulacjami w odpowiednim regionie, w krajach UE produktu nie należy wyrzucać z odpadami domowymi. Produktów opatrzonych tym symbolem nie można utylizować razem z odpadami domowymi.
- CZ** Tento symbol udává, že v zemích EU musí být tento výrobek sbíráán odděleně od domácího odpadu, jak je určeno pro každý region. Výrobky nesoucí tento symbol se nesmí vyhazovat spolu s domácím odpadem.
- SK** Tento symbol vyjadruje, že v krajinách EÚ sa musí zber tohto produktu vykonávať oddelene od domového odpadu, podľa nariadení platných v konkrétnej krajine. Produkty s týmto symbolom sa nesmú vyhazovať spolu s domovým odpadom.
- EE** See sümbol näitab, et EL-i maades tuleb see toode olemprügist eraldi koguda, nii nagu on igas piirkonnas määratletud. Selle sümboliga märgitud tooteid ei tohi ära visata koos olmeprügiga.
- LT** Šis simbolis rodo, kad ES šalyse šis produktas turi būti surenkamas atskirai nuo buitinių atliekų, kaip nustatyta kiekviename regione. Šiuo simboliu paženklinoti produktai neturi būti išmetami kartu su buitinėmis atliekomis.
- LV** Šis simbols norāda, ka ES valstīs šo produktu jāievāc atsevišķi no mājsaimniecības atkritumiem, kā noteikts katrā reģionā. Produkts ar šo simbolu nedrīkst izmest kopā ar mājsaimniecības atkritumiem.
- SI** Ta simbol označuje, da je treba proizvod v državah EU zbirati ločeno od gospodinjjskih odpadkov, tako kot je določeno v vsaki regiji. Proizvoda s tem znakom ni dovoljeno odlagati skupaj z gospodinjjskimi odpadki.
- GR** Το σύμβολο αυτό υποδηλώνει ότι στις χώρες της Ε.Ε. το συγκεκριμένο προϊόν πρέπει να συλλέγεται χωριστά από τα υπόλοιπα οικιακά απορρίμματα, σύμφωνα με όσα προβλέπονται σε κάθε περιοχή. Τα προϊόντα που φέρουν το συγκεκριμένο σύμβολο δεν πρέπει να απορρίπτονται μαζί με τα οικιακά απορρίμματα.

## 有关产品中所含有害物质的说明

本资料就本公司产品中所含的特定有害物质及其安全性予以说明。

本资料适用于 2007 年 3 月 1 日以后本公司所制造的产品。

### 环保使用期限



此标志适用于在中国国内销售的电子信息产品，表示环保使用期限的年数。所谓环保使用期限是指在自制造日起的规定的期限内，产品中所含的有害物质不致引起环境污染，不会对人身、财产造成严重的不良影响。环保使用期限仅在遵照产品使用说明书，正确使用产品的条件下才有效。不当的使用，将会导致有害物质泄漏的危险。

### 产品中有毒有害物质或元素的名称及含量

部件名称	有毒有害物质或元素					
	铅(Pb)	汞(Hg)	镉(Cd)	六价铬(Cr(VI))	多溴联苯(PBB)	多溴二苯醚(PBDE)
外壳(壳体)	×	○	○	○	○	○
电子部件(印刷电路板等)	×	○	×	○	○	○
附件(电源线、交流适配器等)	×	○	○	○	○	○

○：表示该有毒有害物质在该部件所有均质材料中的含量均在 SJ/T11363-2006 标准规定的限量要求以下。  
 ×：表示该有毒有害物质至少在该部件的某一均质材料中的含量超出 SJ/T11363-2006 标准规定的限量要求。  
 因根据现有的技术水平，还没有什么物质能够代替它。



\* 5 1 0 0 3 2 0 4 8 - 0 4 \*