



Operating Instructions

PBM-4K Series



PBM-4K Series

PBM-217-4K

PBM-224-4K

PBM-324-4K

PBM-232-4K

PBM-243-4K

PBM-249-4K

PBM-255-4K

PBM-265-4K

PBM-286-4K

Table of Contents





Ñ	PREACUTION	5
Ñ	OVERVIEW	8
Ñ	ADVANCED FEATURES	8
Ñ	FUNCTIONAL EXPLANATION OF EACH PART	10
1.	FRONT PANEL	10
Ñ	<i>PBM-224-4K</i>	10
Ñ	<i>Front Keys Arrangements</i>	10
Ñ	<i>Front Keys Operations</i>	11
Ñ	<i>Front panel LED Operations</i>	11
Ñ	<i>Speaker Out</i>	11
2.	REAR PANEL	12
Ñ	<i>I/O Details</i>	12
Ñ	<i>DC Battery IN</i>	12
Ñ	<i>RJ-45 Connections</i>	12
Ñ	<i>Interface description</i>	13
4.	MENU OVERVIEW	14
1.	TO SHOW AND REMOVE THE MENU	14
2.	TO GO TO THE NEXT LEVEL	14
3.	TO GO BACK TO THE PREVIOUS LEVEL	14
4.	TYPICAL MENU OPERATION	14
5.	BASIC OPERATION	15
1.	TURNING ON THE MONITOR	15
2.	VOLUME ADJUSTMENT	15
6.	ON SCREEN MENUS SELECTION AND ADJUSTMENT	16
1.	HOW TO ADJUST THE OSD SCREEN	16
7.	SELECT VIDEO INPUT	17
1.	HOW TO SELECT VIDEO SOURCE BY OSD	17
8.	PICTURE MENU OPTIONS	18

1.	ADJUST-----	18
2.	COLOR TEMPERATURE CONTROL-----	18
3.	ASPECT RATIO -----	19
4.	MONO/BLUE ONLY -----	19
5.	PEAKING FILTER -----	20
6.	FALSE COLOR -----	20
7.	HDR MODE-----	20
8.	OUTPUT RANGE-----	21
9.	AUDIO MENU OPTIONS -----	21
1.	SDI OUTPUT-----	21
2.	LEVEL METER -----	22
3.	VOLUME-----	23
10.	MARKER MENU OPTIONS -----	24
1.	MARKER & USER MARKER-----	24
2.	SAFETY AREA -----	24
3.	CENTER MAKER -----	25
4.	MARKER WIDTH-----	25
5.	MARKER COLOR-----	25
6.	PRESET1 & PRESET2 -----	25
11.	GPI MENU OPTIONS -----	26
1.	GPI CONTROL & GPI PORTS -----	26
12.	SETUP MENU OPTIONS -----	27
1.	FACTORY DEFAULT-----	27
2.	FUNCTION 1 ~6 -----	28
3.	ON SCREEN DISPLAY -----	29
Ñ	<i>OSD Option</i> -----	29
Ñ	<i>Time code</i> -----	29
Ñ	<i>Under Monitor Display (color: Tally R/G mode action)</i> -----	29
4.	ADVANCED -----	30
Ñ	<i>Information</i> -----	30
Ñ	<i>Control</i> -----	30
Ñ	<i>Screen Control</i> -----	30
Ñ	<i>Network Configuration</i> -----	31

- 5. CAPTION FOR NORTH AMERICAN MARKET----- 31
- 6. SET ID ----- 32
- 7. VIDEO RANGE----- 32
- 13. OSD TREE----- 33**
 - 1. VIDEO ----- 34
 - 2. AUDIO----- 35
 - 3. MARKER ----- 36
 - 4. GPI ----- 37
 - 5. SETUP ----- 38
- 14. MECHANICAL DIMENSION ----- 39**

PREACUTION

Before operating this unit, please read this manual carefully.

  WARNING RISK OF ELECTRIC SHOCK DO NOT OPEN	 The lightning flash with arrowhead symbol, within an equilateral triangle, is intended to alert the user to the presence of uninsulated "dangerous voltage" within the product's enclosure that may be of sufficient magnitude to constitute a risk of electric shock to persons.
WARNING : The unit is operated at dangerous voltages. The unit may only be opened by an authorized specialist. All maintenance and servicing work must be carried out by an authorized company. Repairs that are carried out incorrectly could result in fatal injuries to the user.	 The exclamation point within an equilateral triangle is intended to alert the user to the presence of important operating and maintenance (servicing) instructions in the literature accompanying the appliance.

WARNING:

To reduce the risk of any electric shock, please do not remove the back cover. No user serviceable parts inside. Refer any service matters to qualified service personnel. To prevent fire or shock hazard, do not expose the rear of the set to rain or moisture. Do not rub, clean or hit the Active Matrix LCD with object that may scratch, mark, or damage the Active Matrix LCD permanently.

CAUTION:

Unauthorized tampering with the inside of the monitor invalidates the warranty.

The manufacturer shall not warrant for any damage caused by improper maintenance and/or repair or work by third parties.

Important safeguards for you and your new product:

Your product has been manufactured and tested with your safety in mind. However, improper use can result in potential electrical shock or fire hazards. Please read and observe the following safety points when installing and using your new product and save them for future reference.

- 1. Read Instructions**
- 2. Follow Instructions**
All operating and use instructions should be followed.
- 3. Retain Instructions**
The safety and operating instructions should be retained for future reference.
- 4. Notice Warnings**
All warnings on the product and in the operating instructions should be adhered to.
- 5. Cleaning**
Disconnect the unit from the mains before cleaning the unit. Do not use abrasive cleaners. Use a damp cloth ONLY for cleaning.
- 6. Water and Moisture**

Do not use this product near water surface.

7. Transporting Product

This product should be moved with care. Quick stops, excessive force and uneven surfaces may cause the product damages.

8. Accessories

Do not use accessories not recommended by PLURA Inc. as they may cause hazards.

9. Ventilation

Do not block any of the ventilation openings.

Install in accordance with the manufacturer's instructions.

10. Power Sources

This product should be operated only from the type of power source indicated on the marking label. If you are not sure of the type of power supply, consult your power supply company.

11. Power Lead Polarization

This product is equipped with a three-wire grounding-type cord. This is a safety feature. Do not use any other type power cord.

12. Power Cord Protection

Power-supply cords should be dressed so that they are not likely to be pulled or pinched by items placed upon or against them.

13. Lightning

For added protection for this product during a lightning storm, or when it is left unattended and unused for long periods of time, unplug it from the wall outlet. This will prevent possible damage to the product due to lightning and power-line surges.

14. Grounding the product

This product must be grounded properly to comply with the safety regulations in the country of use. If you are unsure of these regulations, please consult a qualified electrician.

15. Servicing

Do not attempt to service this product by yourself as opening or removing covers may expose you to dangerous voltages or other hazards. Refer all servicing to qualified service personnel.

16. Damage Service Required

Isolate this product from the mains and refer to qualified service personnel under the following conditions:

- A. *If the power-supply cord or plug is damaged.*
- B. *If the front LCD front has been damaged.*
- C. *If the product does not operate correctly by following the operating instructions. Use only the user control buttons any improper adjustment of other controls may result in damage and will often require extensive work by a qualified technician to restore the product to its normal operation.*
- D. *If the product has been dropped.*

E. *If the product exhibits a distinct change in performance.*

17. Safety Check

Upon completion of any service or repairs to this product, ask the service technician to perform safety checks to determine that the product is in proper operating condition and the warranty seal is provided.

18. Mounting

The product should be mounted on a wall as recommended in the instructions.

19. Power

This set operates on an AC supply; the voltage is as indicated on the label on the Manual. This appliance must be earthed at all times through the chassis as well as through the power lead.

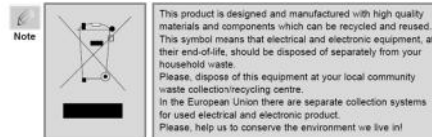

OVERVIEW

The Plura PBM-4K series is a multi-format 4K/UHD capable monitor series. The Plura PBM-4K is a great tool for all UHD/4K, 3G broadcast systems and all other wide-range industries. The PBM-4K series was designed and engineered for simple operation and future flexibility. The platform is built around a powerful FPGA chipset. The core of this platform is based on fully programmable architecture. Future proof expansion (i.e. additional features and functionalities) can and will be implemented in the field via the Ethernet interface.

The PBM-4K series comes in multiple sizes 17", 24", 32", 43", 55" & 65" & 84", all sizes offer the extensive and well-know Plura prominent features.

PBM-4K Series, which supports up to 4096 x 2160 resolutions, focuses on delivering the highly detailed, accurate color representation and stunning picture consistency that high-end production applications require. The PBM-4K series offers HDR Display capabilities supporting PQ (ST-2084) & HLG standards.

The Plura PBM-4K Series, will support SMPTE 2082 and other earlier industry standards, 2 x 12G/3G/HD-SDI inputs with active loop, 1 x SFP slot to support multiple IP & fiber I/O standards, 1 x HDMI 2.0, in addition to all other legacy I/O.

ADVANCED FEATURES

The new PBM-4K has the following advanced features:-

-) 1 x HDMI 2.0
-) 2 x 12G, 6G, 3G, 1.5G
-) 1 x SFP Slot supporting Multiple Standards
-) Quad 3G SQ and 2SI with 4KXpress
-) 10 bit panel color depth
-) Supports up to 4096 x 2160 resolutions
-) HDR (High Dynamic Range) capabilities
-) PQ (SMPTE ST 2084) & HLG (Hybrid Log Gamma)
-) Side by side HDR / SDR mode
-) RGB 12 Bit Digital Signal Processing
-) 178° Viewing Angle Display
-) Gamma Selectable (0.8 – 3.0)
-) Color Temperature – User, VAR, Adjustable (11000K TO 3200K)
-) (ICAC) - Plura Intelligent Connection for Alignment & Calibration
-) 3D LUT (ITU-R BT 2020, Native, BT.709, SMPTE-C, EBU, NTSC, D-Cinema, 709)
-) Display Advanced Waveform & Vector Scope simultaneously with line select.

-) Various and User defined Markers Display, Safe Area
-) Programmable 6 User Front Pushbutton Controls & GPI
-) Closed Caption (608/708) – North American Market
-) Cutting edge De-interlacing and Scaling Technology
-) Fast Response Time for high motion video
-) Internal Monitor Display (IMD)
-) Ethernet & RS232 Remote Control
-) Underscan / Overscan / Normal / Zoom
-) Pixel to Pixel Mode, Tally, DC Operation
-) False Color and Peaking Filter / Focus Assist
-) Video Range test with adjustable Y & C values
-) Display LTC & DVITC time code with line select
-) Embedded Audio Input, Digital Audio Decoding
-) Internal Pattern Generator and Wall Control System
-) Built In Stereo Speaker, 16 CH Audio Metering Display

Functional explanation of each part

1. Front Panel

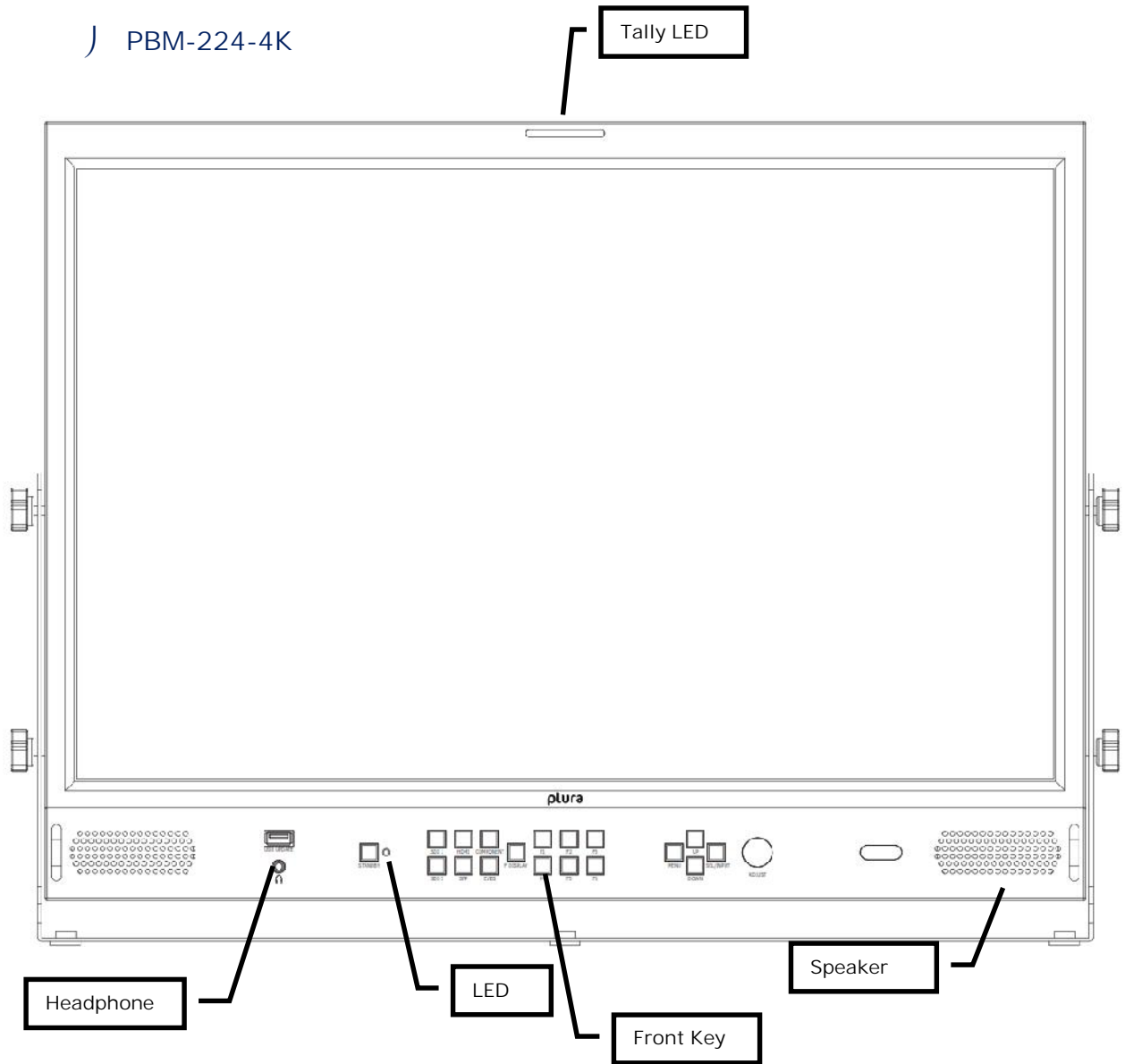

Front Keys Arrangements

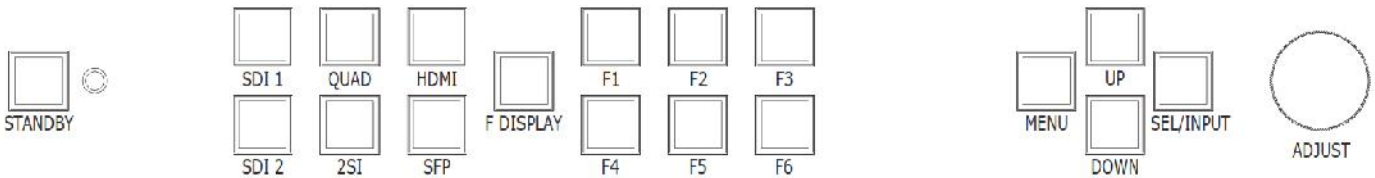

) Front Keys Operations

Key Name	Operation
STANDBY	▶ Power ON/OFF Button.
SDI 1	Select SDI 1.
SDI 2	Select SDI 2.
QUAD	Select QUAD.
2SI	Select 2SI.
HDMI	Select HDMI.
SFP	Select SFP.
F DISPLAY	Display Functions settings.
F1 ~ F6	Executes user defined functions i.e. Undefined, Aspect, Audio LV Meter, Audio Group, Audio Channel, H/V Delay, Mono/Blue only, Gamma select, Marker size, Safety Maker Size, Marker Preset1, Marker Preset2.
MENU	▶ Activates main OSD menu. ▶ Navigates higher menu levels in main OSD menu. ▶▶ Exit OSD menu.
UP	▶ Increases speaker volume. ▶ Increases values for certain menu functions. ▶ Executes function (by OSD help commands) in main OSD menu.
DOWN	▶ Decreases speaker volume. ▶ Decreases values for certain menu functions. ▶ Executes function (by OSD help commands) in main OSD menu.
SEL/INPUT	▶ Activates and select input source. ▶ Changes input source. ▶ Executes functions (by OSD help commands) in main OSD menu.
Adjust	Adjust Menu parameters (Volume -> Brightness -> Contrast -> Color -> Sharpness-> & Tint) Turn Right = to UP button Turn Left = to DOWN button

) Front panel LED Operations

- Stand-by mode = LED is Red

) Speaker Out

Interface	Description
Speaker R out	8 ohm±15%, Max 2W + 2W
Speaker L out	

2. Rear Panel

I/O Details

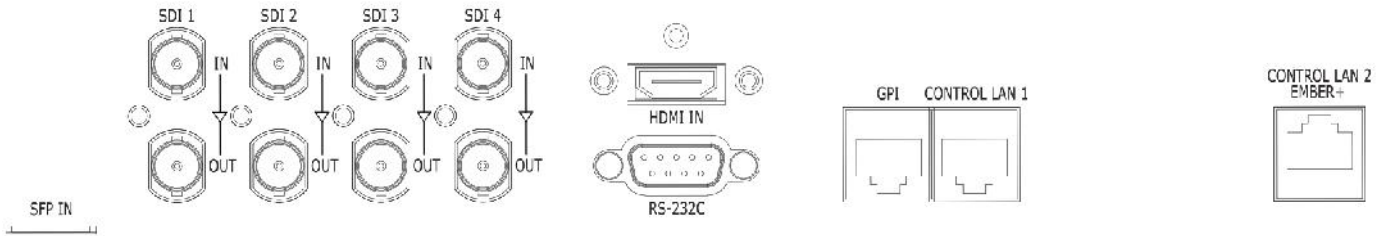

DC Battery IN

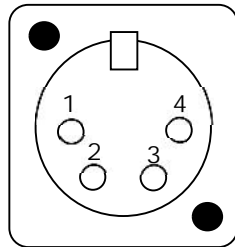

DC IN 12V PBM-217-4K ONLY

DC IN 24V PBM-224-4K & PBM-324-4K ONLY

PIN NO	Description
1	GND
2, 3	
4	12-24V

RJ-45 Connections

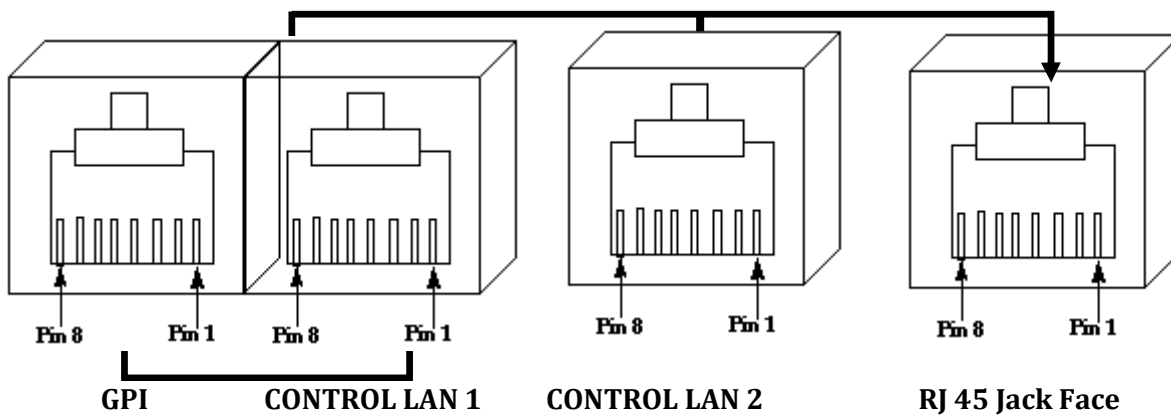

Ember+

- Firmware Upgrade/ System Controller / Ember+ (Ethernet) & GPI

Remote PIN Assignment			
8 PIN	COMMON(GND)	4 PIN	GPI 4 PORT
7 PIN	GPI 7 PORT (STAND BY/POWER ON/OFF)	3 PIN	GPI 3 PORT
6 PIN	GPI 6 PORT	2 PIN	GPI 2 PORT
5 PIN	GPI 5 PORT	1 PIN	GPI 1 PORT

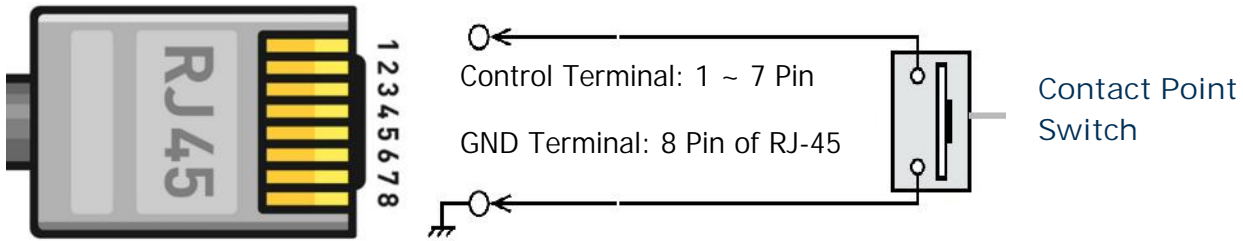

) Interface description

Interface	Description
SDI 1 IN	12G/QUAD 3G/2SI/3G/HD SDI Input 1
SDI 2 IN	12G/QUAD 3G/2SI/3G/HD SDI Input 2
SDI 3 IN	QUAD 3G/2SI SDI Input 3
SDI 4 IN	QUAD 3G/2SI SDI Input 4
SDI 1 OUT	12G/QUAD 3G/2SI/3G/HD SDI Output 1
SDI 2 OUT	12G/QUAD 3G/2SI/3G/HD SDI Output 2
SDI 3 OUT	QUAD 3G/2SI SDI Output 3
SDI 4 OUT	QUAD 3G/2SI SDI Output 4
SFP	SFP Module x 1(SFP 12G Input)
HDMI	High Definition Multimedia Input
RS232C	Auto color calibration
USB	Firmware Upgrade
GPI	GPI 1 ~ 7 Control Port
CONTROL LAN1	Network System Control
CONTROL LAN2	Network System Control (EMBER+)
AC IN	AC90V ~ 240V, 50Hz/60Hz
DC IN	DC 12V PBM-217-4K, DC 24V PBM-224-4K, PBM-324-4K

4. MENU OVERVIEW

In this system menu, there are several ways to maneuver the menu settings.

Most menus consist of three levels to select the necessary option, but some settings require greater depth. If you press the MENU button, the first and second level of the menu system will appear on the monitor screen. The third level can be displayed by pressing SEL/INPUT. If a menu has more than three levels, the pop-up dialogue box will be displayed as the fourth or fifth level.

1. To show and remove the Menu

Press the MENU button to display the menu. Press the MENU button again to hide the menu.

2. To go to the next level

Press SEL/INPUT button.

3. To go back to the previous level

Press MENU button

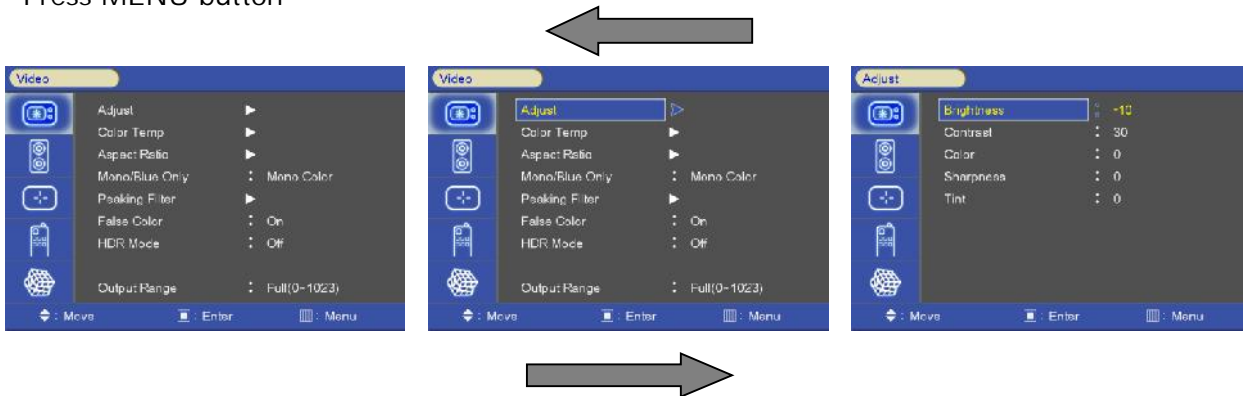

4. Typical Menu Operation

1. Press MENU button: The main menu will be displayed.
2. Use UP/DOWN button to select the desired menu option (icon).
3. While the desired menu option is selected, press SEL/INPUT to move to the second level.
4. Use UP/DOWN button to select the second menu option.
5. Press SEL/INPUT to move to the third level: Some menu options require additional steps.
6. Press MENU to return to the previous menu to return to monitor viewing.

5. BASIC OPERATION

1. *Turning On the Monitor*

1. Firstly, make sure you have connected the AC power cord or DC XLR connector. The monitor will switch to standby or power on mode. If the monitor is in standby mode, press the ST-BY button to turn on the monitor.
2. Select the source by using SEL/INPUT button on Keypad in front of monitor

2. *Volume Adjustment*

1. Press the ADJUST button on Keypad.
2. Press the MENU button on Keypad.
 - OSD Audio menu -> Volume menu.



6. On Screen Menus Selection and Adjustment

1. How to adjust the OSD screen

1. Press the MENU button and then UP/DOWN button to select each menu.
2. Press the SEL/INPUT button and then use UP/DOWN (SEL/INPUT)/MENU button to display the available menu.

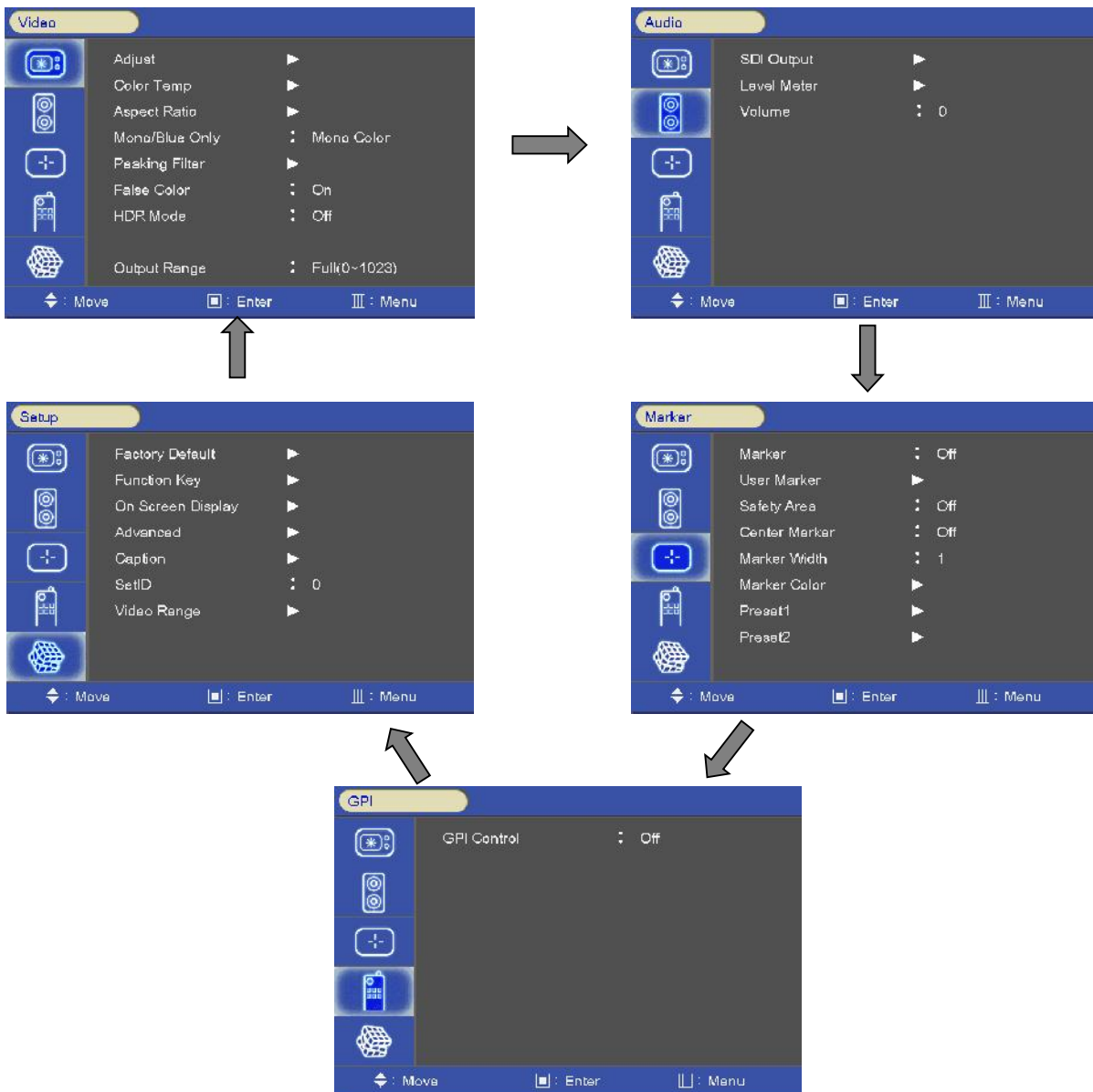

- The monitor's OSD (On Screen Display) may differ slightly from what is shown in this manual.

7. SELECT VIDEO INPUT

1. *How to Select Video Source by OSD*

1. Press the SET/INPUT button and then UP/DOWN button to select the required video source.
2. Press the SET/INPUT button to select the desired video source.
3. If Input Name is enabled, The SET/INPUT button will show the input name previously programmed instead of the source name.

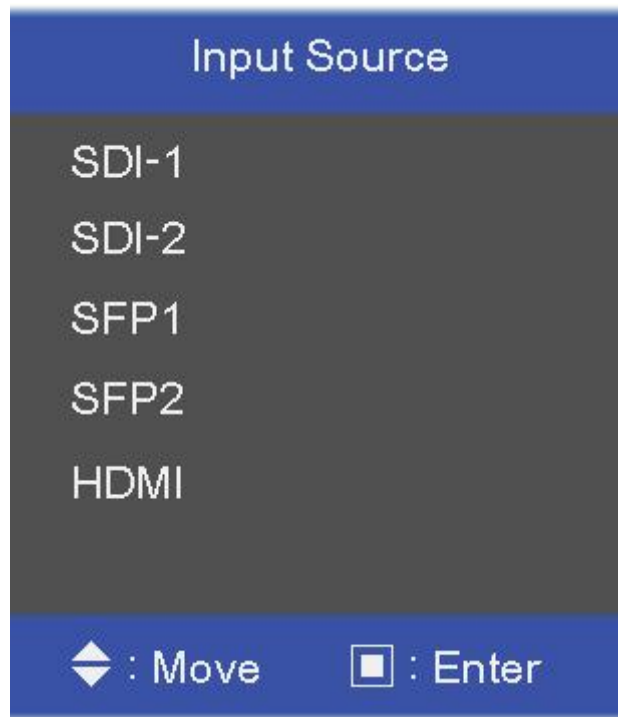

8. PICTURE MENU OPTIONS



1. Adjust



- Adjust the values of Brightness, Contrast, Color, Tint and Sharpness range from -50 to 50

2. Color Temperature Control



- For Setting the Color temperature or adjusting RGB gain value
- User (User setting RGB gain value), VAR(3200K ~ 9300K), Most common value (9300K, 6500K, 5400K,3200K) and 3D LUT Calibration value(D65 – 6504K/C-6774K/D-Cinema 6302K)
- Color Space: Native/BT.709/SMPTE-C/EBU/NTSC/D-Cinema/BT.2020

3. Aspect Ratio



- For setting the aspect ratio.
- Pixel to Pixel: Video input will match the video display resolution (NO Scaling). If input resolution is higher than panel resolution, the video will be downscaled to match the panel resolution.
- Full Screen: The video input will be scaled to the max panel resolution.
- Pixel to Pixel, Full Screen, 16:9, 4:3, 14:9, 13:9, 1.85:1, 2.35:1: The video will displayed with based on the selected aspect ratio.
- Function key can be assigned to the aspect ratio and will be rotating through this sequence, Pixel to Pixel, Full Screen, 16:9, 4:3, 14:9, 13:9, 1.85:1, 2.35:1
- AFD (Auto Format Direct) function can be turned ON or OFF

4. Mono/Blue Only



- Mono color: For selecting monochrome images.
- Blue Only: Blue Video channel is enabled

5. Peaking Filter



- Peaking Filter: Peaking Filter On/Off.
- Peaking Color: Red/Blue/White/Violet.
- Peaking Level: 0~100.

6. False Color



- False Color on/off

7. HDR Mode



- ST 2084-300 / ST 2084-1000 / ST 2084-10000 / HLG
- HDR Demo on/off

8. Output Range

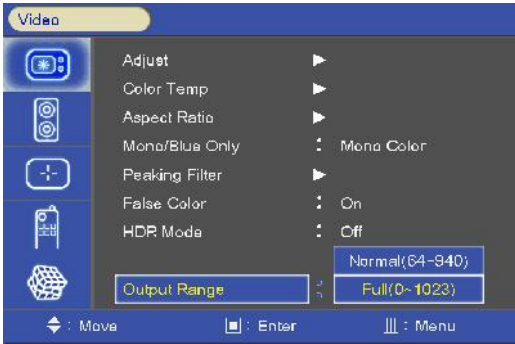

- Normal (16~235)/Full (0~255)

9. AUDIO MENU OPTIONS

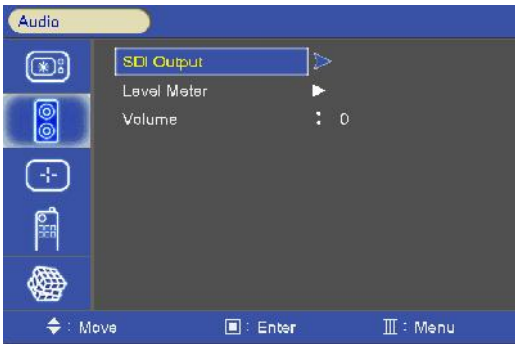

1. SDI Output

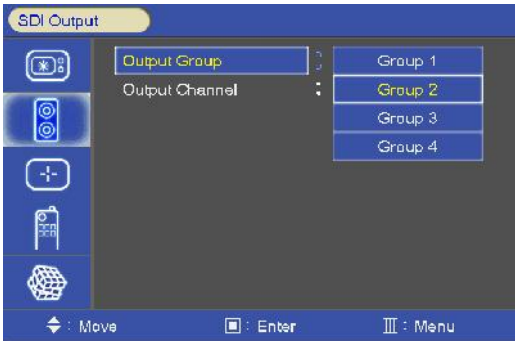

- Select primary or secondary audio group to extract. (Group 1~4)
- Audio output channel source select. (Channel1~4, Channel1/2, Channel3/4, off)

2. Level Meter



- Display the audio level meter on screen in SDI input.

-Pair: Respectively By Audio Pair (L&R) display

-Group: Respectively By Audio Group display



- Level Meter Position selects. (TOP/Bottom)

- Level Meter Scale mode selects. (BBC / EBU / VU / NORDIC / DIGITAL / DIN / EXPAND DIN)

AUDIO SCALES

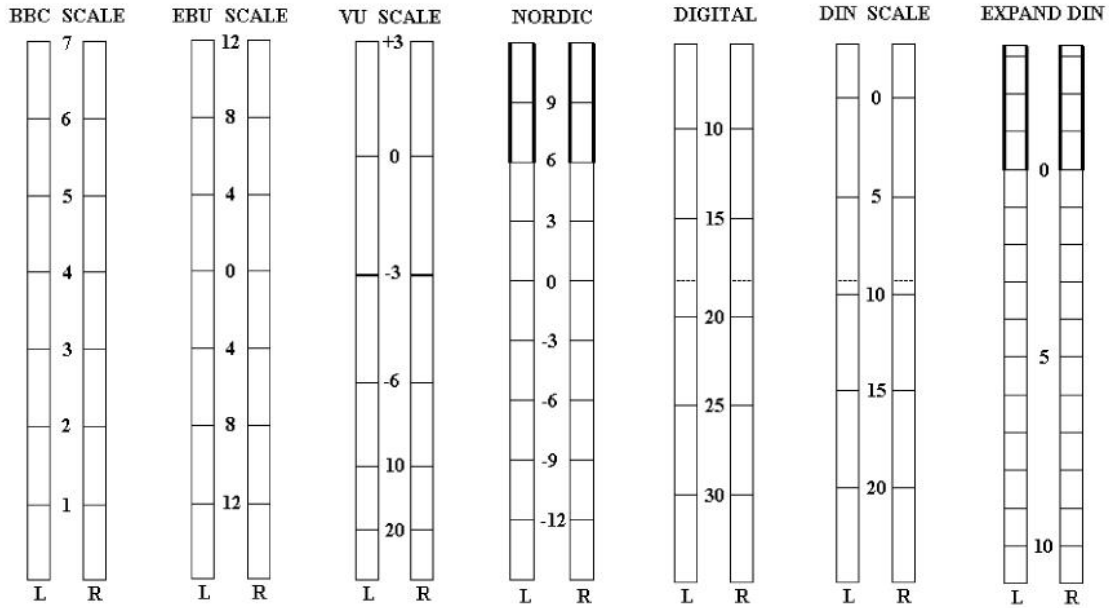

3. Volume

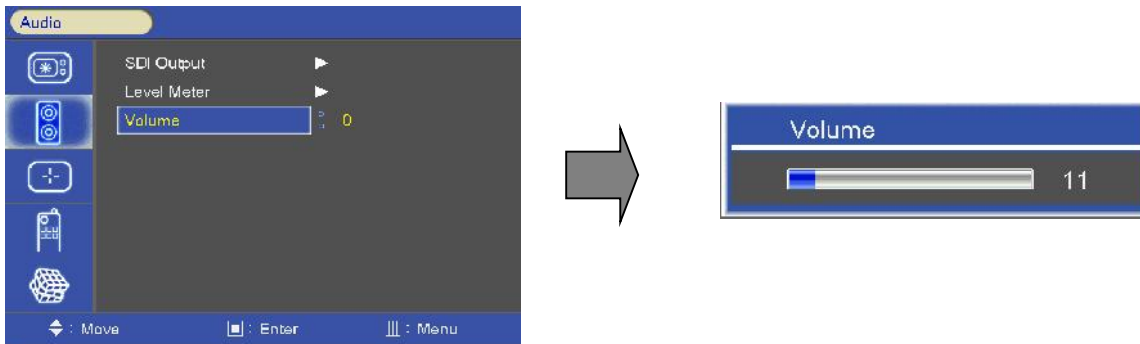

- Adjust the speaker or headphone Volume level. (0~32)

10. Marker MENU OPTIONS



1. Marker & User Marker



- Marker : 16:9, 4:3, 14:9, 13:9, 1.85:1, 2.35:1, 1.85:1&4:3, User1, User2, User3 (Customized markers).
- User Marker: The user defined Marker size setting.

2. Safety Area



-Safety Area: Draw dotted line Marker on screen. (16:9 95/93/90/88/80%, 4:3 95/93/90/88/80%, EBU Action 16:9/14:9/4:3, EBU Graphic 16:9/14:9/4:3)

3. Center Maker

- "+" display Marker on center of screen

4. Marker Width

-Marker line thickness setting. (0~10)

5. Marker Color



- Marker Line Color: Select Marker line color (White, Yellow, Blue, RED, Black)

- Safety Line Color: Select Safety line color (White, Yellow, Blue, RED, Black)

- Marker Back Color: Select Marker Back Color. (None, Gray, White, Blue, Black)

- Safety Back Color: Select Safety Back Color. (None, Gray, White, Blue, Black)

- Marker BK Blend Color: Select Marker blending level. (0 ~ 5)

- Safety BK Blend Color: Select Safety blending level. (0 ~ 5)

6. Preset1 & Preset2

- Markers can be set as preset 1 & 2 and be triggered by GPI controller.

- GPI preset markers can only be utilized by GPI controller

11. GPI MENU OPTIONS

1. GPI Control & GPI Ports

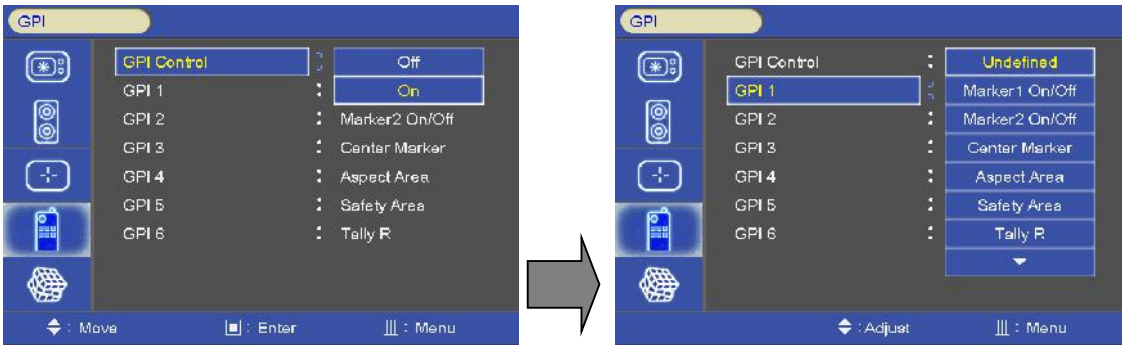

- For programming selected functions to particular GPI ports.
- GPI Controller can be utilized to remotely control the monitor.
- GPI Control: GPI function Enable/Disable
- GPI 1 ~ 7

GPI Function	Description
UNDEF	Not set (no function allocated)
Marker1 On/Off, Marker2 On/Off	Displays the markers which have been set by the GPI PRESET 1 & 2 items.
Center Marker	Displays the center marker.
Aspect Area	For setting the aspect ratio.
Safety Area	Displays the Safety Area.
Tally R, Tally G	For displaying the Red, Green or Amber (if you select R & G at the same time) tally LED.
SDI1, SDI2, HDMI, SFP1, SFP2	Switches the input source.

Menu Key, Enter Key, Up Key, Down Key	Use the key function by GPI.
Left Key, Right Key	
Function key1 ~ 6	Function key1 ~ 6
H/V delay	H delay, V delay, HV delay, Off
Aspect	Full Screen, 16:9, 4:3, 14:9, 13:9, 1.85:1, 2.35:1
GPI 7 : Power Key(Fixed)	

12. SETUP MENU OPTIONS



1. *Factory Default*



- Factory Default: User Reset.

2. Function 1 ~6



- Function 1~6: Select the required function to be allocated to the FUNCTION Keys 1, 2, 3, 4, 5, 6.

Function1 ~6 button	Description
UNDEF	Not set (no function allocated)
Aspect	Sets the aspect ratio
Audio Lv Meter	Audio Level Meter On / Off
Audio Group	Select the embedded audio Group in SDI input.
Audio Channel	Select the embedded audio channel in SDI input.
Audio mute	Toggles between mute & un-mute speaker/headphone.
H/V delay	H delay, V delay, HV delay, Off
Mono/Blue Only	Execute Mono color or Blue Only
Gamma Select	Select Gamma curve.
Marker size	Select Marker size
Safety Marker size	Select Safety Marker size
Marker Prese1/2	Marker Preset 1/2 on/off

3. On Screen Display

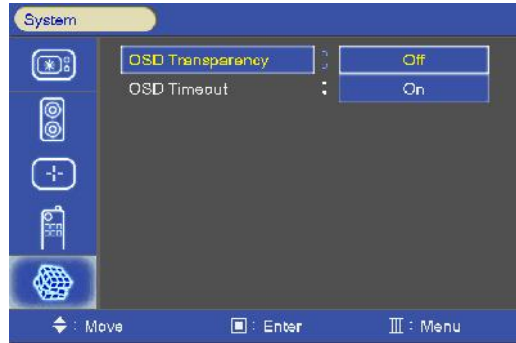
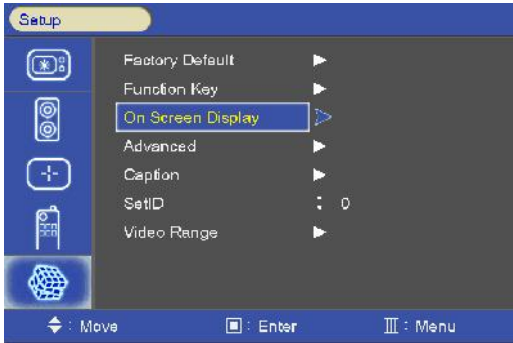

) OSD Option

→ OSD Transparency: Disable blending OSD background with video image.

→ OSD Time out: OSD time display setting. (3~200)

) Time code



→ Time code Enable: Time code Display (off/LTC/DVITC, SDI only)

→ Time code size: Time code size select. (Small, Middle, Large)

→ Time code Position: Time code display position selects (L-T, C-T, R-T, L-B, C-B, R-B)

→ Time code Transparency: Disable blending Timecode background with video image. (0%, 25%, 50%, 75%, 100%)

) Under Monitor Display (color: Tally R/G mode action)



UMD



Tally Red



Tally Green

→ UMD: UMD display on/off

→ UMD Character: UMD Character Select

→ UMD Position: UMD display positions select (L-T, C-T, R-T, L-B, C-B, R-B)

→ UMD FG Color: UMD Character color Select (RGB_255_192_128_Transparent)

→ UMD BG Color: UMD BG color Select (RGB_255_192_128_Transparent)

4. Advanced

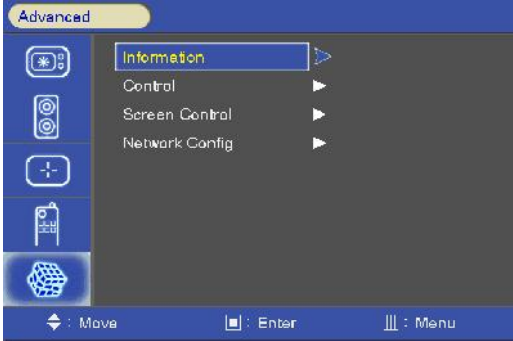

- Information, Control, Screen Control, Network Configuration

) Information

- Version, Release day, Release time, operating time, FPGA Version

) Control

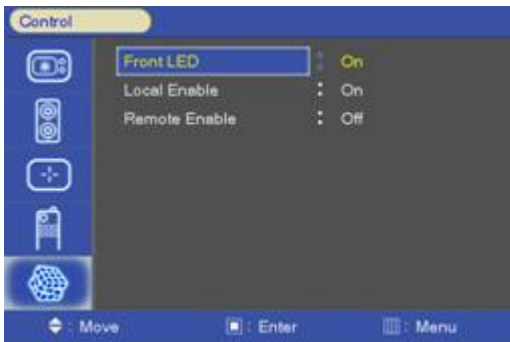

- FRONT LED: Front LED on/off

- Local Enable: Power, up and down key is only operational, if Local enable is off.

- Remote Enable: Select the controller of local or remote. If remote controller is selected, both local (front key) and remote are operational. However when local is selected, local key only

operational.

) Screen Control

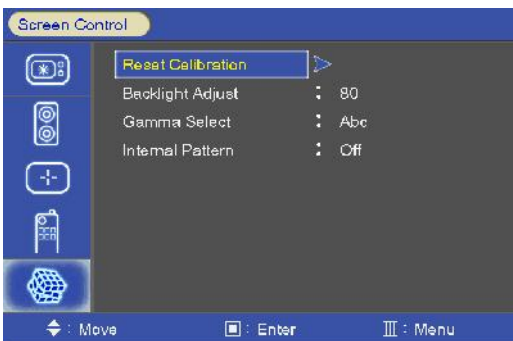

-Reset Calibration

→Color Calibration Reset

-Backlight Adjust

→ Inverter dimming Level select (0~100)

- Gamma Select

→ Gamma Level Select (0.8 ~ 3.0)

- Internal Pattern:

→ 100% Color Bars, 75% Color Bars, Luma, RGB, White, Black, RED, Blue, Green

Network Configuration

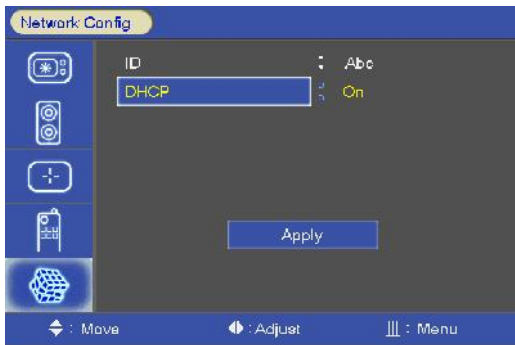

→ DHCP: DHCP on/off (Manual IP settings – DHCP on)

* "Apply" to confirm all settings were applied.

5. Caption For North American Market

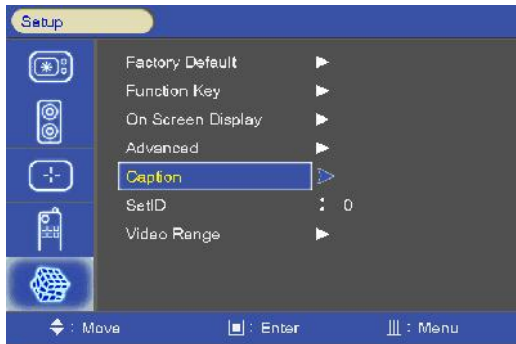

- Closed Caption Mode: 608 Line21, 608 ANC, 608 Transcoded, 708 mode Select

- 608 Caption channel: C/C1, C/C2, C/C3, C/C4, TEXT1, TEXT2, TEXT3, TEXT4

- 708 Caption Service: Service 1/Service 2

6. Set ID

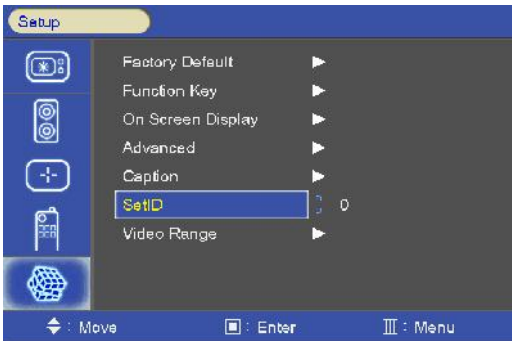

- Set ID is required for remote control. Set ID range (01~99).

7. Video Range

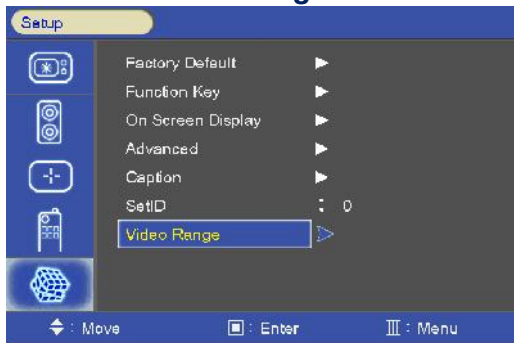

- Range Check: Range Check on/off.
- Y Max: Maximum luminance level.
- Y Min: Minimum luminance level.
- C Max: Maximum chroma level.
- C Min: Minimum chroma level.
- Color: Black/Blue/Red/Green
- Grid: Grid line on/off
- Blink: Y/C Min-Max to blink. (0~7)

13. OSD TREE

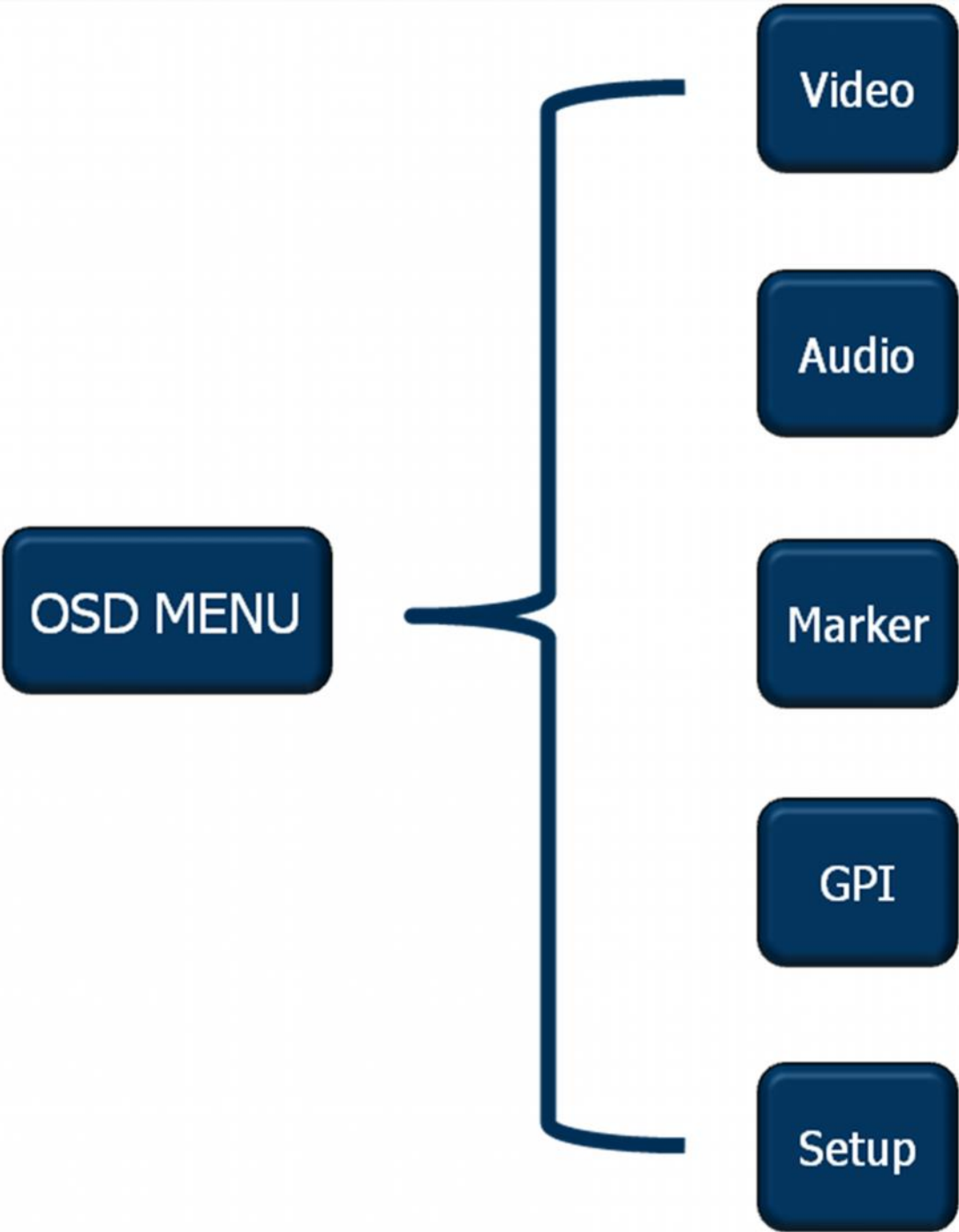

1. Video

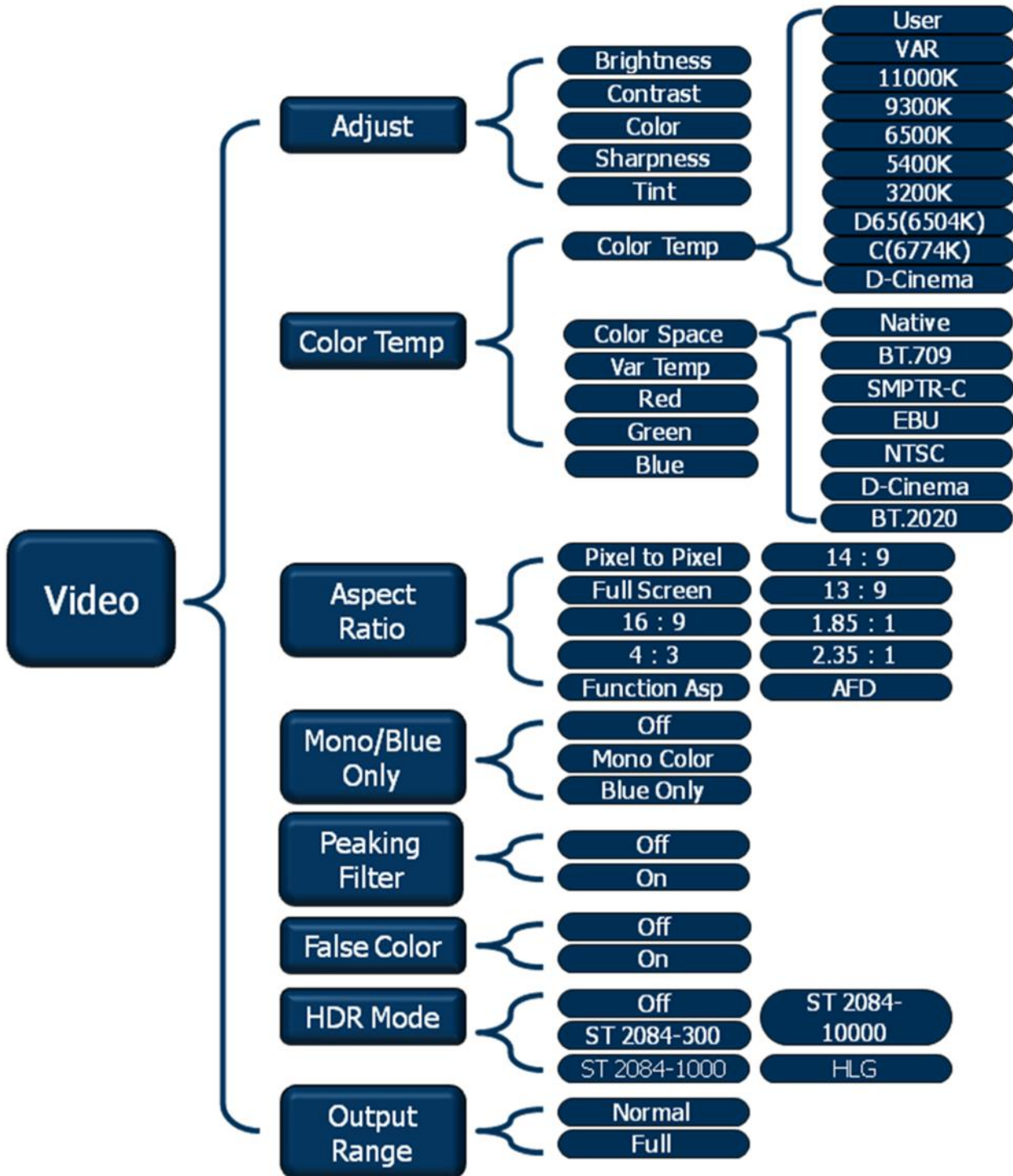

2. Audio

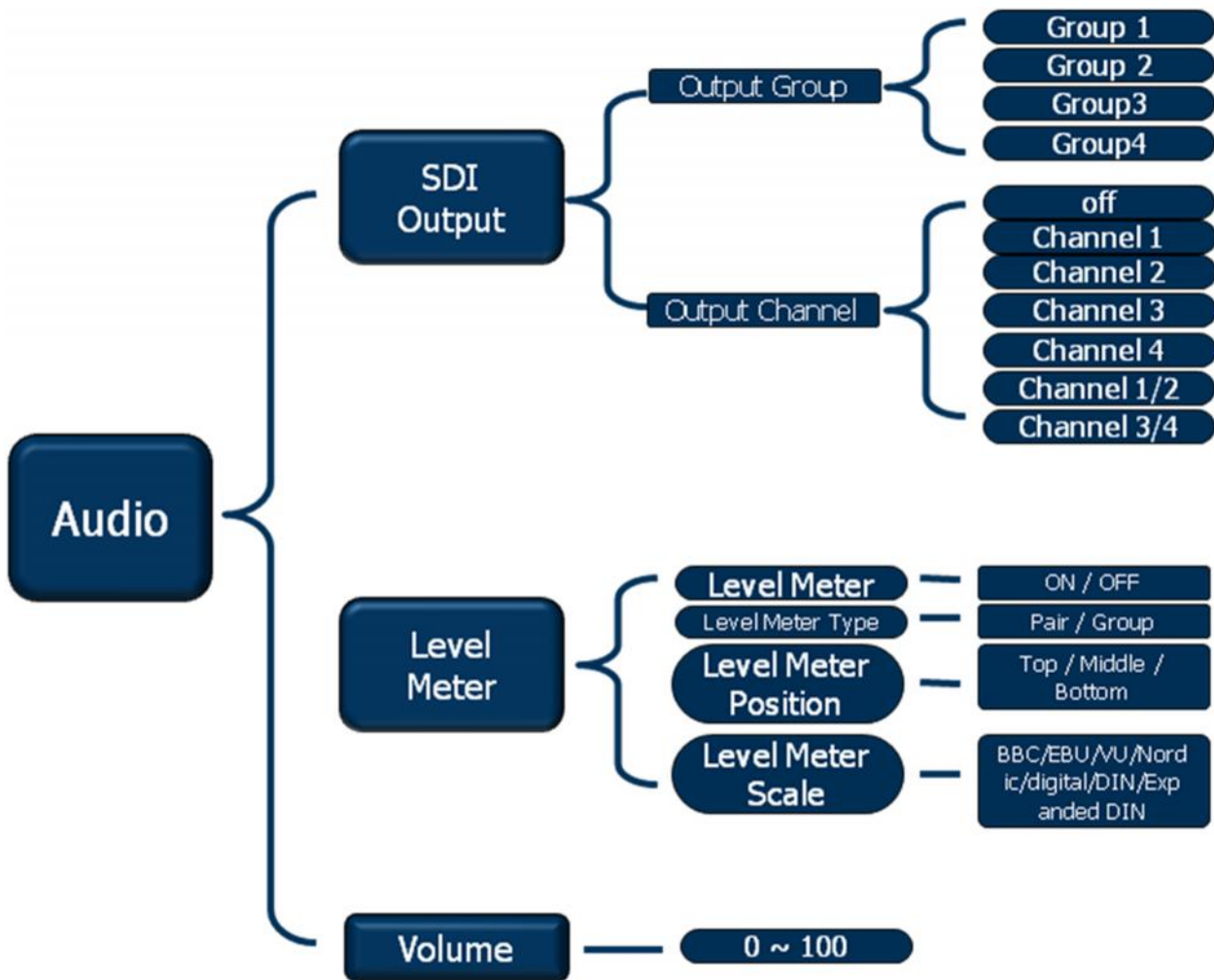

3. Marker

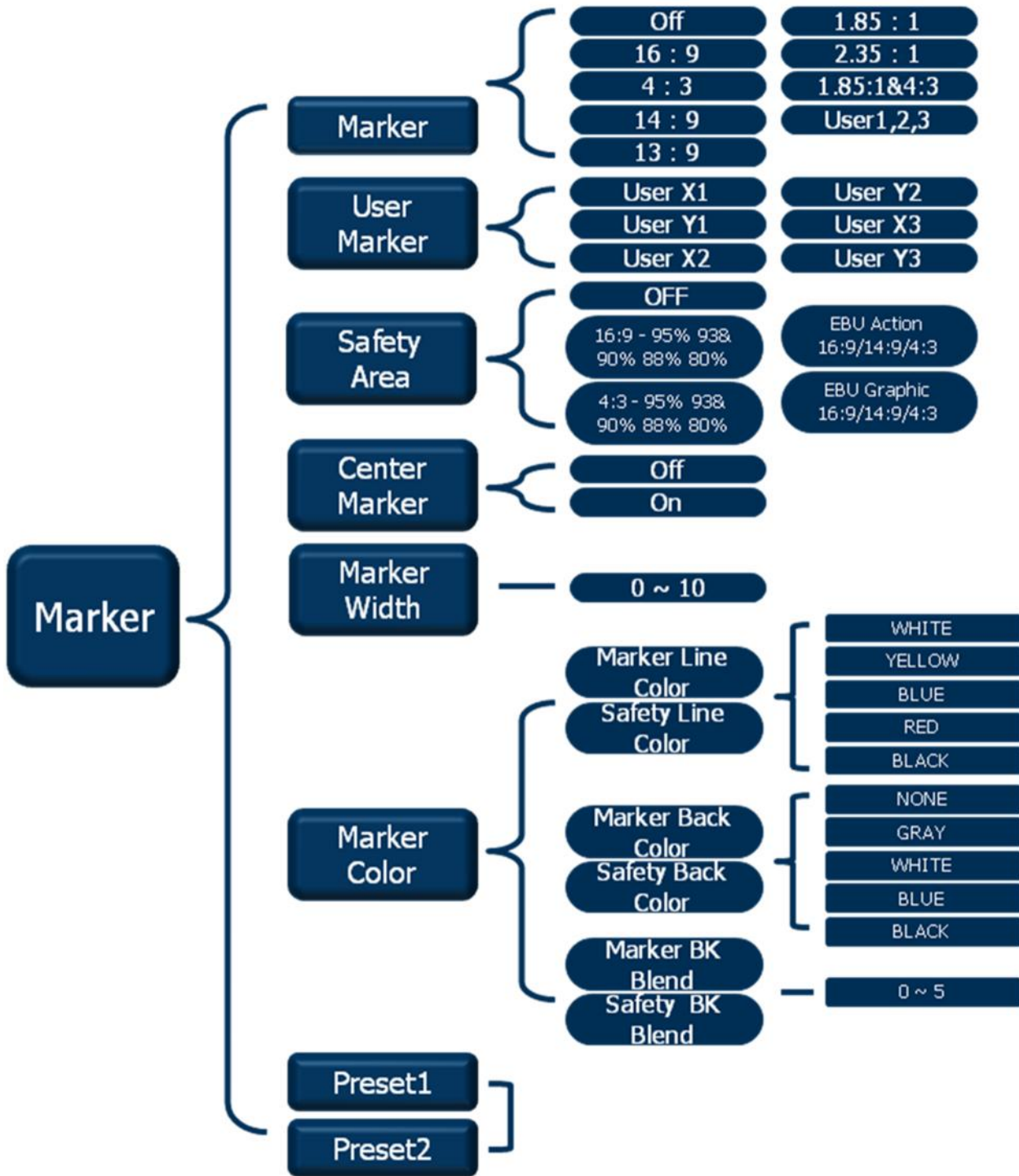

4. GPI

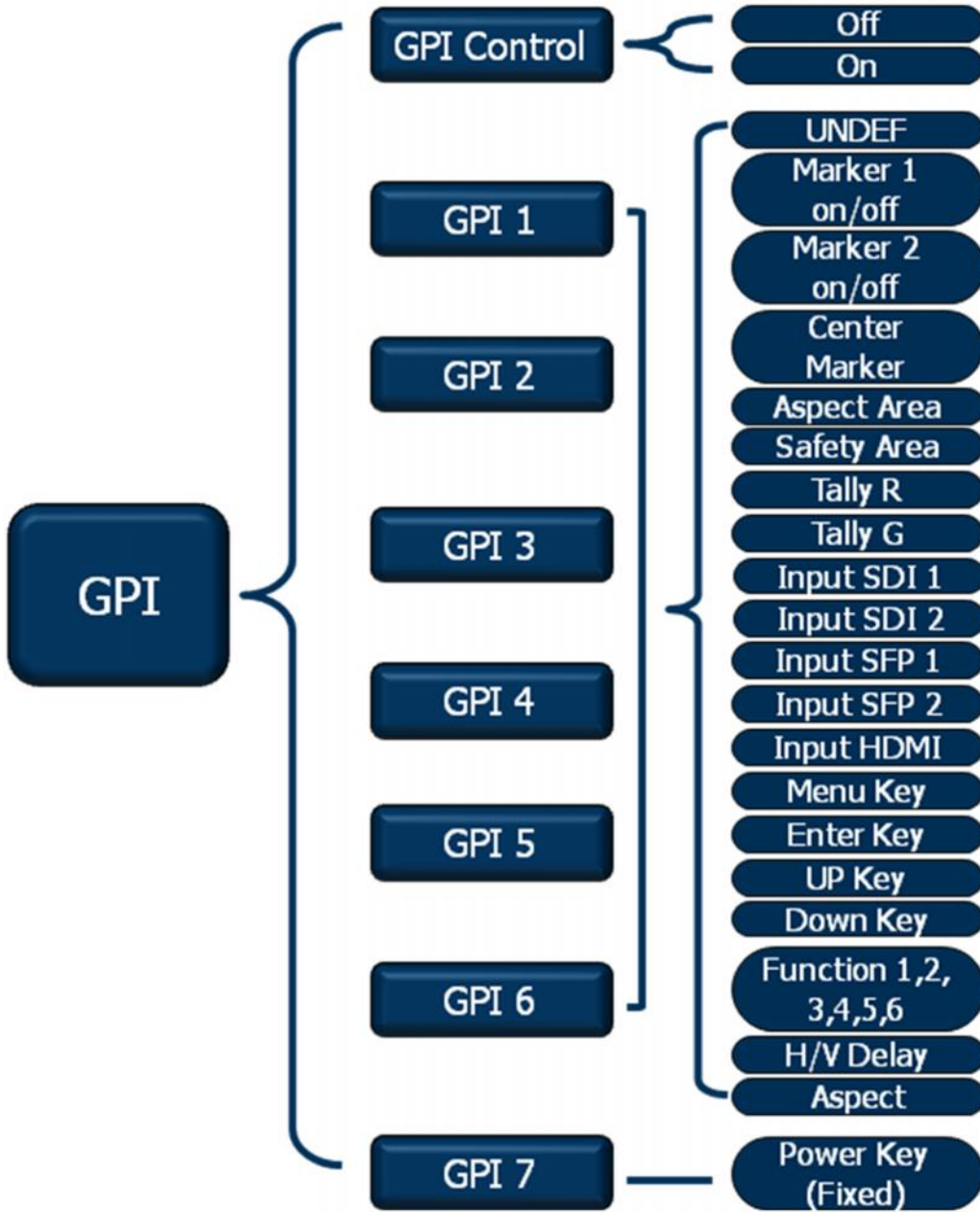

5. Setup

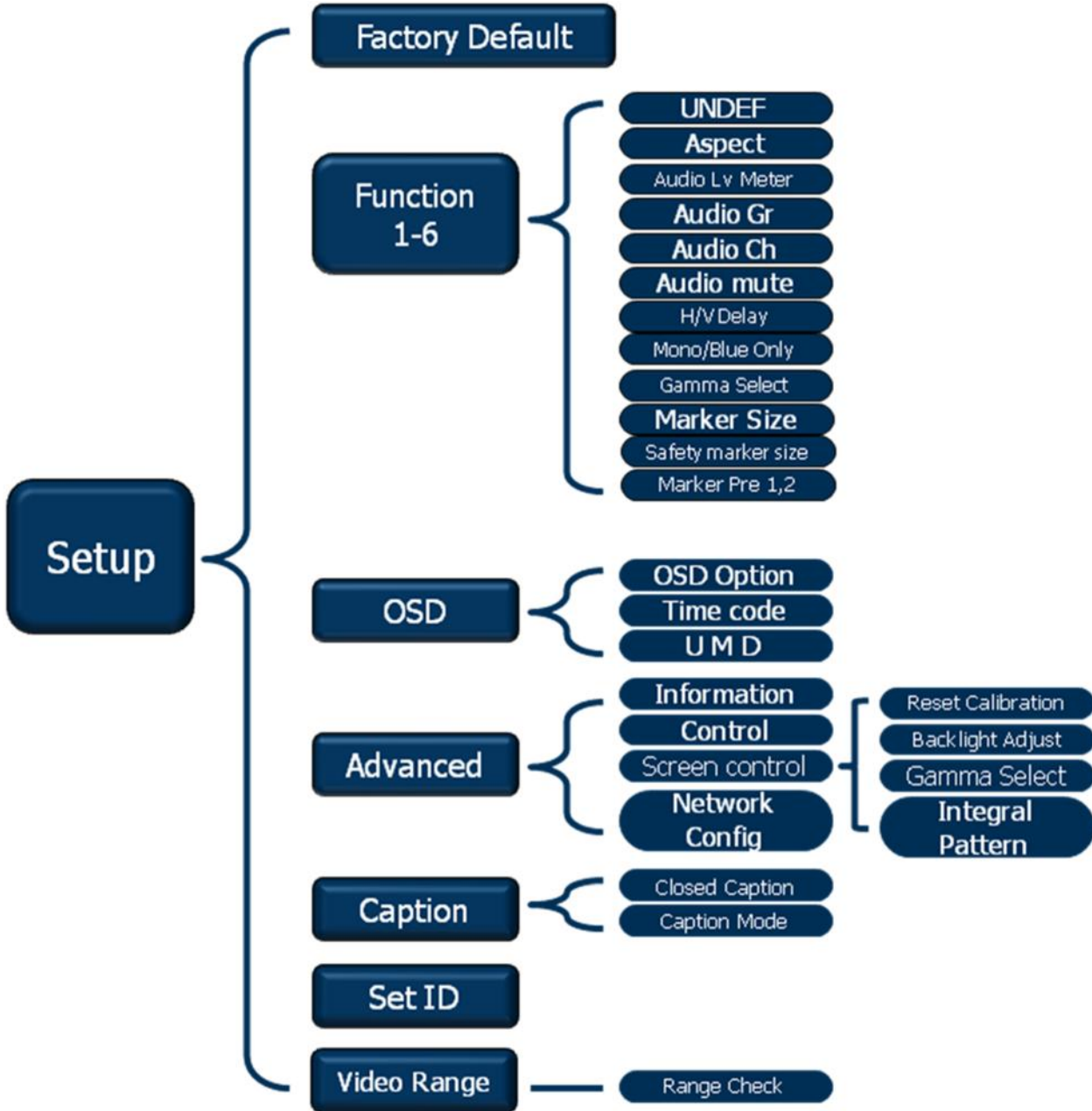

14. Mechanical Dimension

- PBM-217-4K

*AutoCad.dwg available upon request

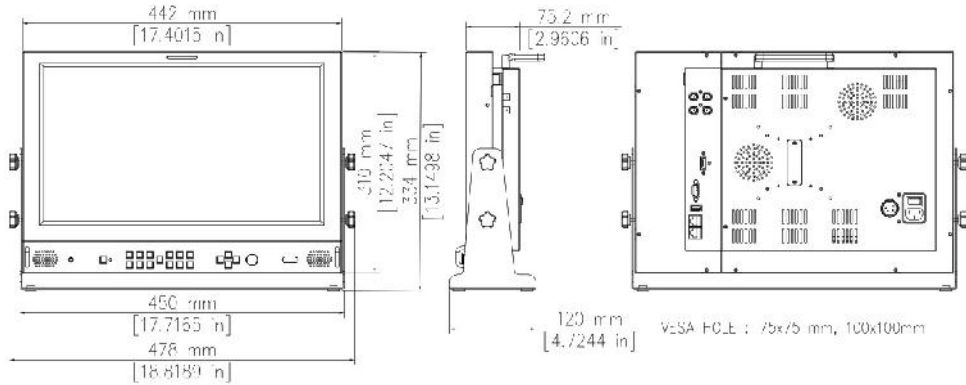

- PBM-224-4K / PBM-324-4K

*AutoCad.dwg available upon request

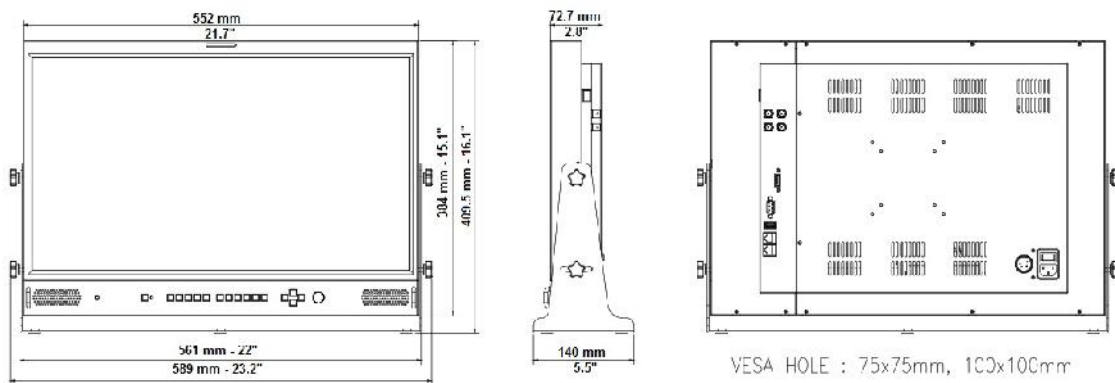

- PBM-232-4K

*AutoCad.dwg available upon request

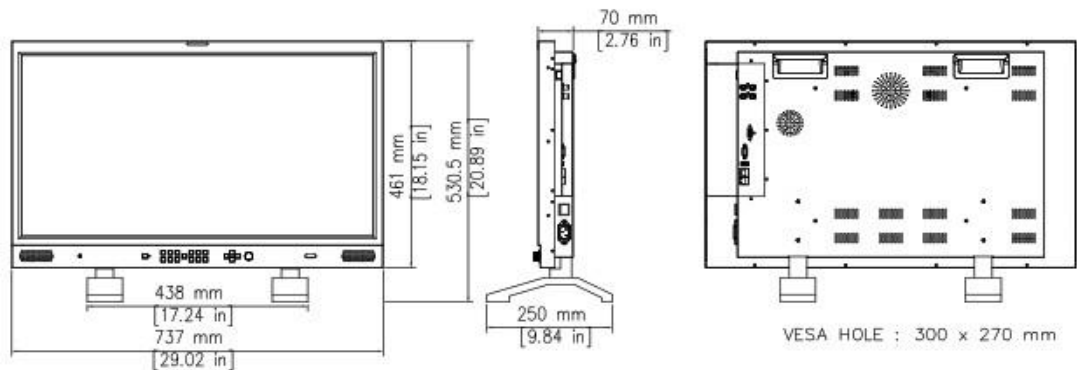

- PBM-232-4K-N
*AutoCad.dwg available upon request

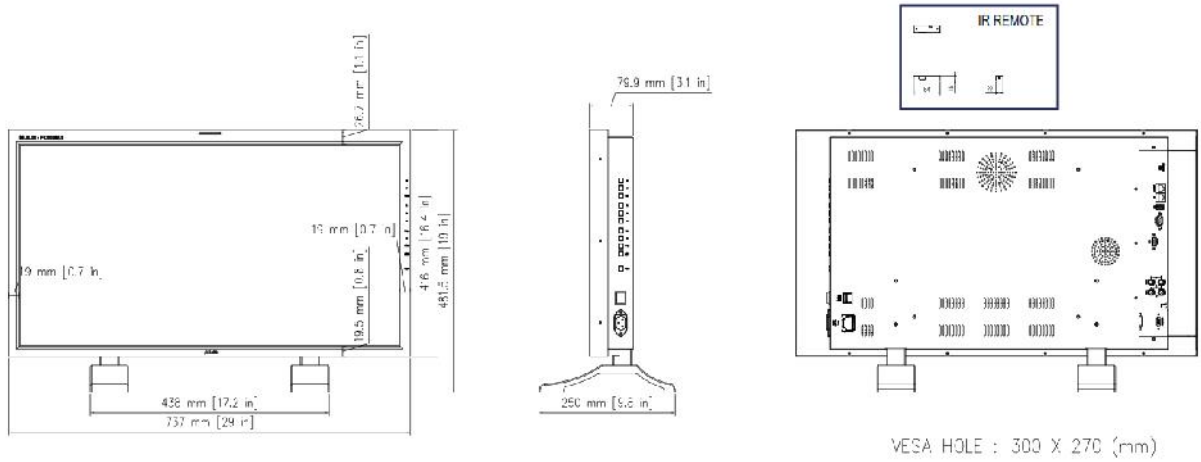

- PBM-249-4K
*AutoCad.dwg available upon request

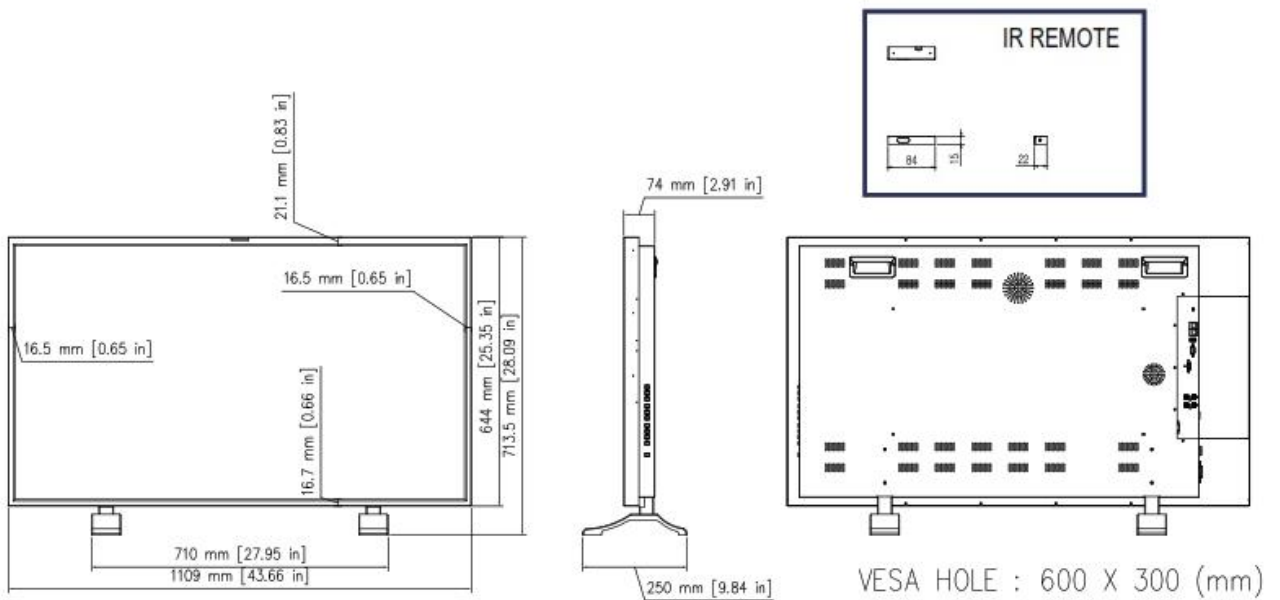

- PBM-255-4K
*AutoCad.dwg available upon request

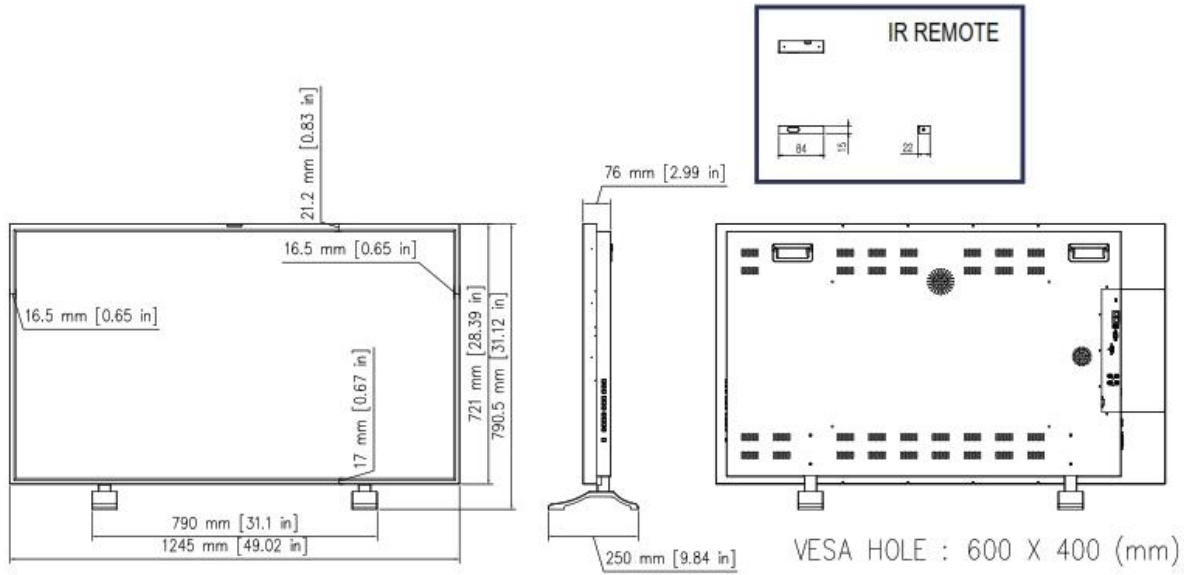

- PBM-255-4K-O
*AutoCad.dwg available upon request

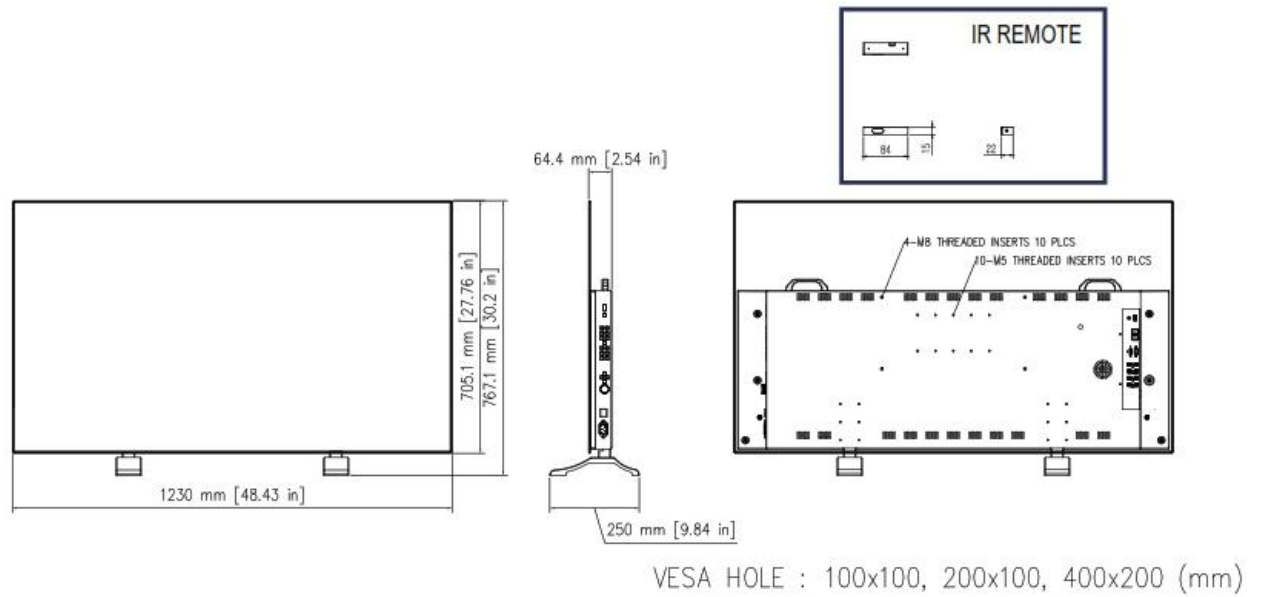

- PBM-265-4K
*AutoCad.dwg available upon request

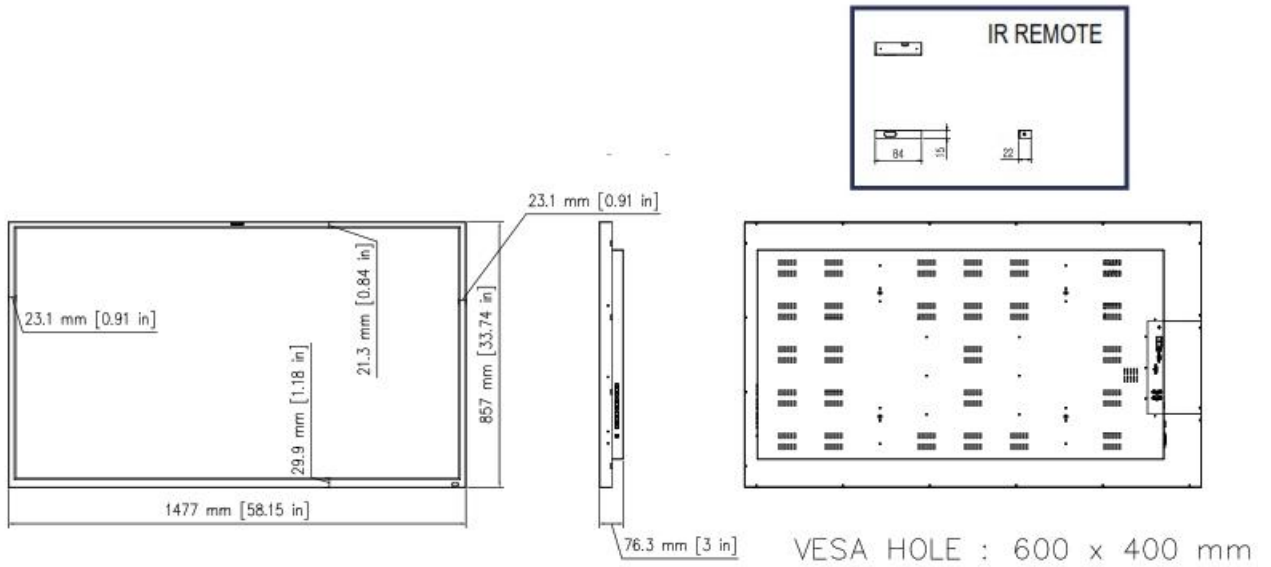

- PBM-286-4K
*AutoCad.dwg available on request

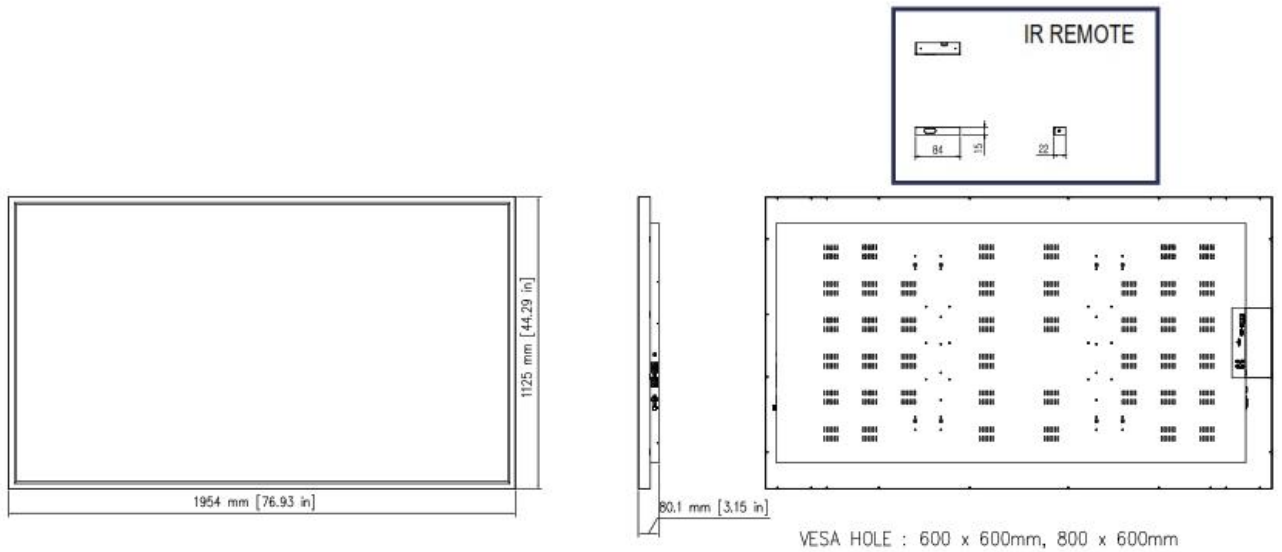

plura[®]

www.plurainc.com

U.S.A. . Germany . U.A.E. . S.Korea